



Gebesa | CREATING AMAZING SPACES

START

4

Start

14

Typicals

15

Accessories

16

Quick Ship

20

Finishes and Textures



START

Start allows you to maximize your space and your budget, offering the best combination of design, quality and price. Thanks to minimal components, Start is easy to install. It is also easy to expand, allowing for a large number of combinations to meet any space-planning need with customized configurations and high aesthetic value.

Optimize and save space with the strategic positioning of surfaces and bases as you elevate the functionality of each work area with accessories to enhance your work experience.

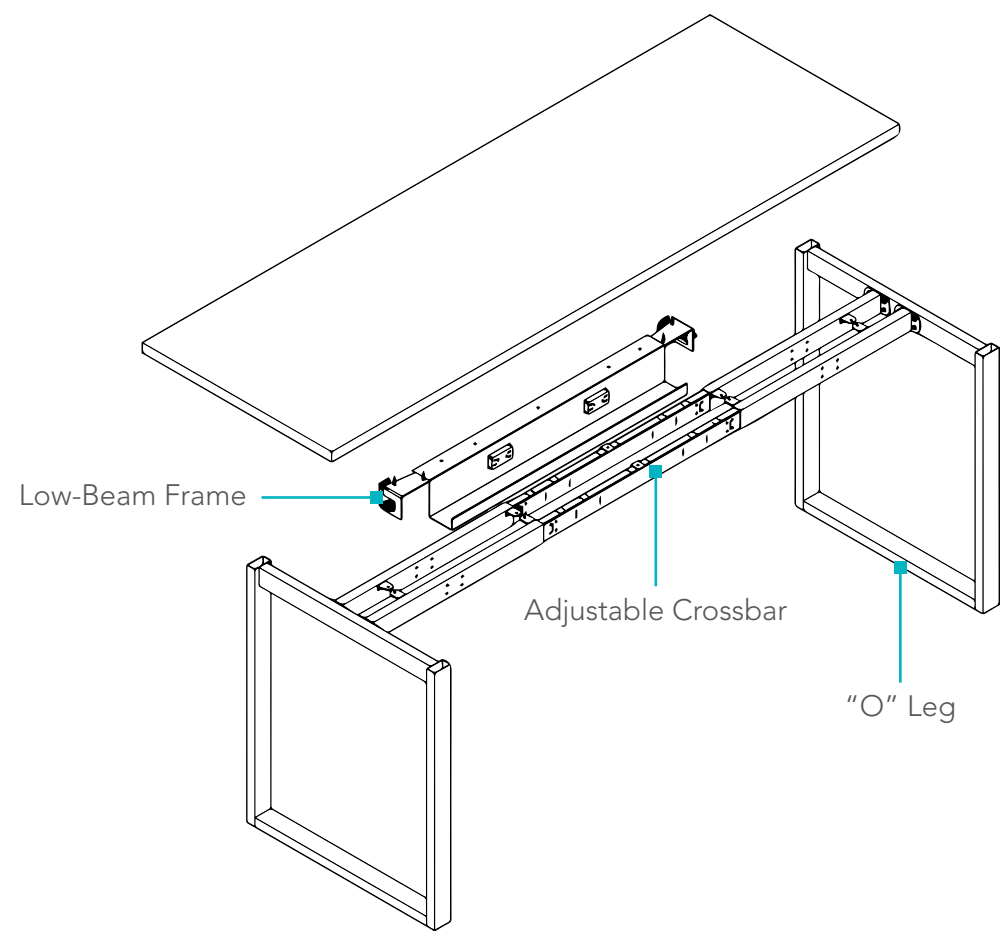

SINGLE RUN

Optimize space in linear configuration with a single run system that offers hidden electrical access for voice and data.



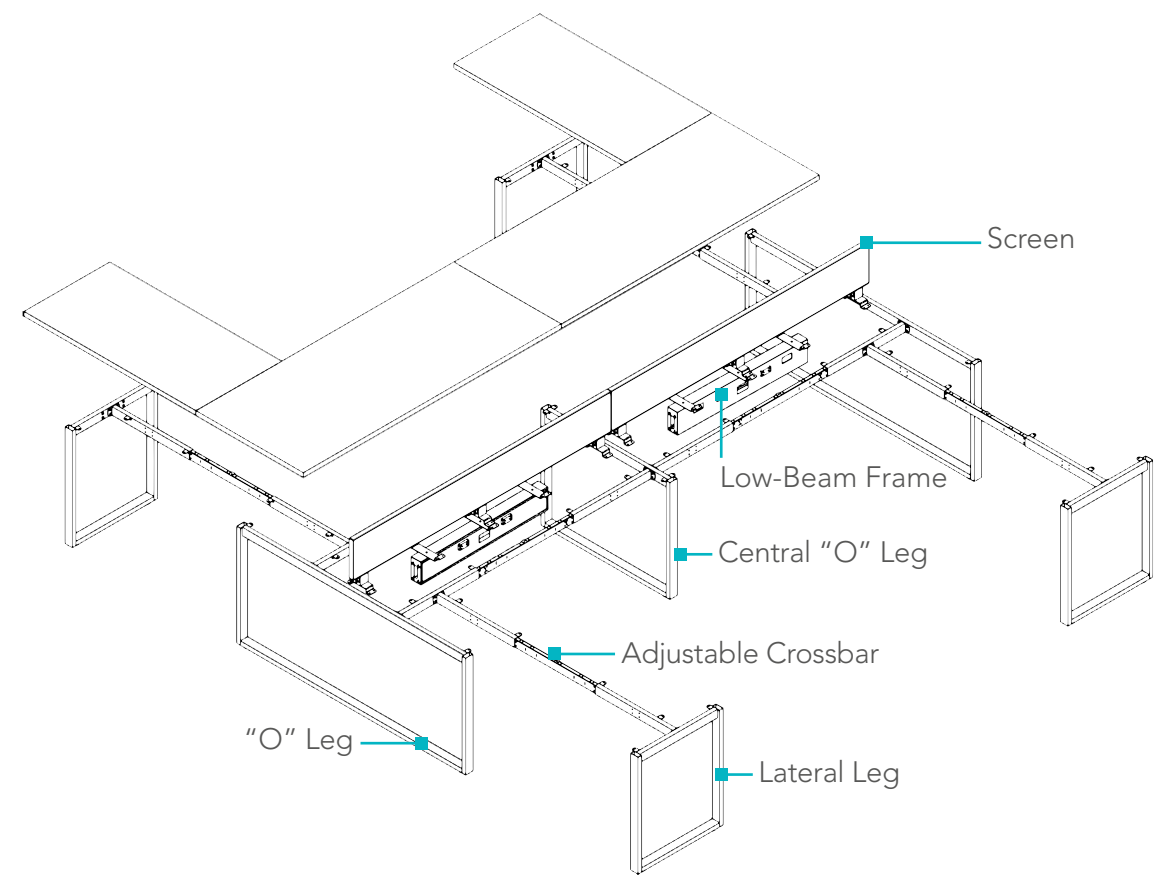

DOUBLE RUN

Start is perfect for the optimization and expansion of space and resources in offices with large work teams. With benching and double run systems, each workstation can adapt to technology demands with electrical access to voice and data in both directions.

THE KEY TO ADAPTABILITY

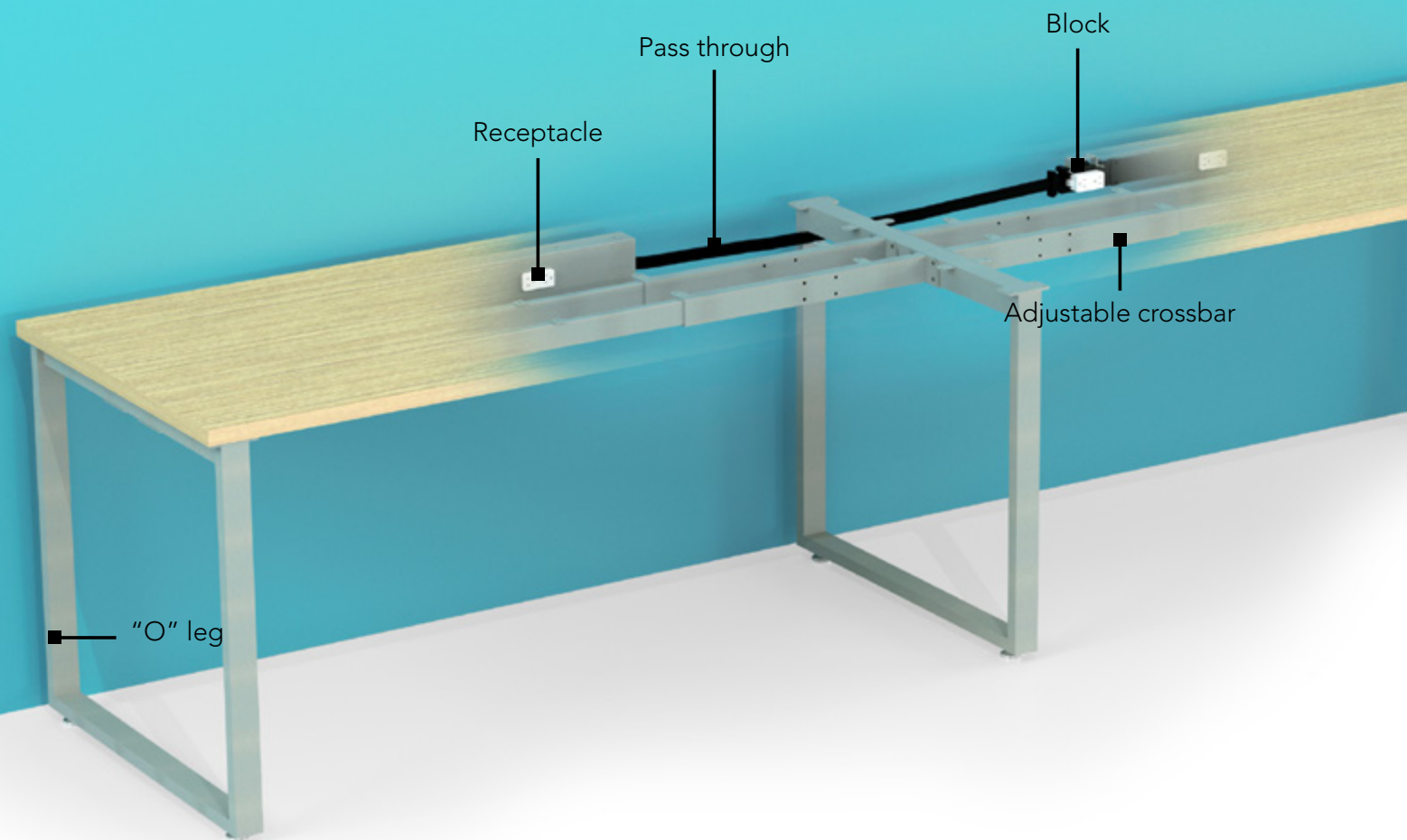

Thanks to the flexibility of Start, adapting to change is easier than ever.

Optimize responsiveness to changes in configurations. Go from a single run to a double run system to accommodate increases in work staff and the overall growth of your organization.

Adapt basic workstations to benching with a quick change of covers and repositioning of the adjustable crossbar. Add bases to increase the number of stations.



BASE

Adapt your work area's dimensions and design with Start's various base options, including central, "O" and side legs, along with adjustable crossbar, ducts and gutters. For metal body colors, choose among black, white, textured aluminum and RM Gray.

ADJUSTABLE CROSSBAR

Base finishes:
Black, White, RM Gray,
Textured Aluminum

Height (with top):
30"

Adjustable crossbar:
For configurations from 48°
to 72°

Warranty:
10 years

Electrification:
Optional

Work surface widths:
48", 60", 66" and 72"

Work surface depths:
24" and 30"

ADJUSTABLE CROSSBAR

The adjustable crossbar lends stability to your furniture and reinforces the cover. It can expand to the size of the stringer, thanks to a design that opens and closes as needed.

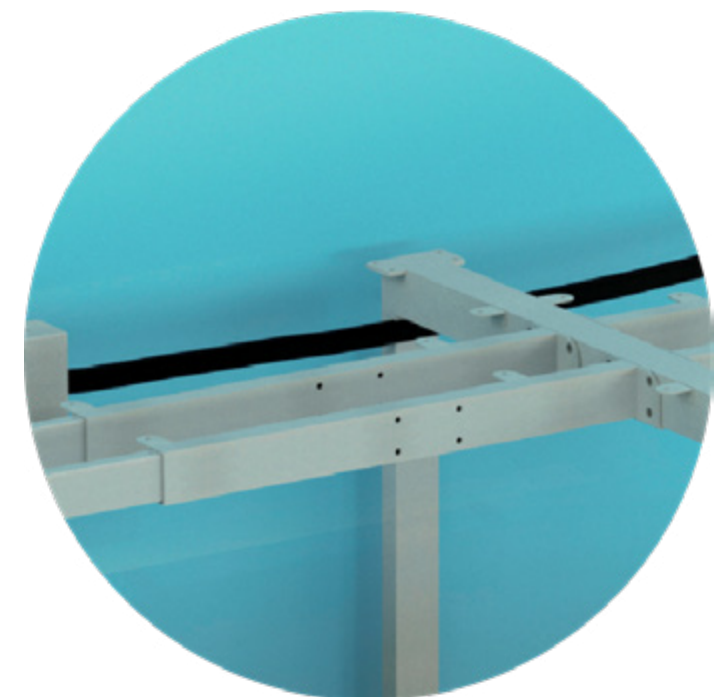



BEAM

Beam Power & Data Distribution System

Beam's flexible design keeps cables hidden, providing electrification in each station through knockouts, harnesses and ducts under covers. Choose the Beam benching version for double run configurations with users on both sides or single run for individual stations.

TYPICALS

2-USER



Option A



Option B



Option I

3-USER

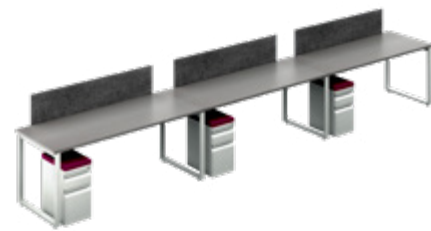

Option C

4-USER



Option D



Option E



Option F

6-USER

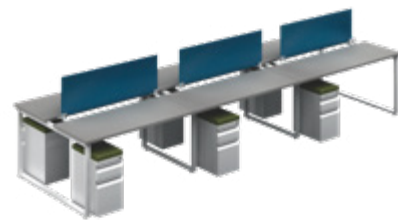

Option G



Option H

SCREENS AND CLAMPS



Fabrics



Acrylic

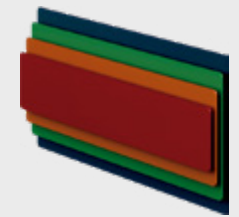

MDF



Clamps

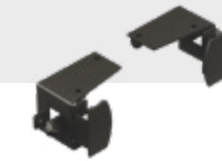

Screen Holder



Metal Freestanding Screen

ORGANIZATION / MOUNTING

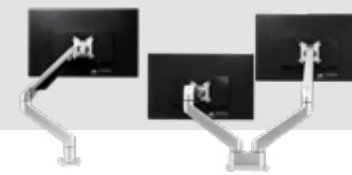

Monitor Arms



Vertebrae



Power Data



Soft Cable Management

STORAGE



Metal Pedestals
12" and 15"

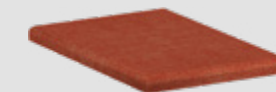

Pedestal Cushion



Metal Pedestals with Laminate Top



QUICK SHIP PRODUCTS

BASES

DESCRIPTION

CODE

DIMENSIONS



LATERAL LEGS

- Colors: Black, Textured Aluminum
- Single run
- For Start work surface only

GAR826060

24" x 28"

GAR826075

30" x 28"



"O" LEG

- Colors: Black, Textured Aluminum
- Double run
- For 24" and 30" work surfaces
- For Start work surface only

GAR825130

52" x 28"

GAR825160

63" x 28"



CENTRAL LEG DOUBLE RUN

- Colors: Black, Textured Aluminum
- Single and double run

GAR827090

36 x 28"



ADJUSTABLE CROSSBAR

- Colors: Black, Textured Aluminum
- Single run
- For Start work surface only

GAR867010

Adjustable from 42" to 72"



BENCHING BEAM

- Colors: Black, Textured Aluminum

GAH839090

34" x 2.75" x 6"

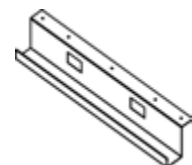

BENCHING BEAM SINGLE RUN

- Colors: Black, Textured Aluminum

GAR841075

29" x 4" x 5"

QUICK SHIP PRODUCTS

SURFACES

DESCRIPTION

CODE

DIMENSIONS

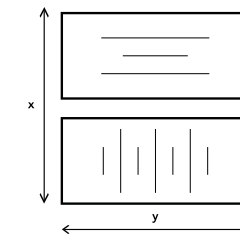

Horizontal (H) Vertical (V)

Width (y) x Depth (x) x Thickness (z)

STRAIGHT WORK SURFACE

- Colors: White, Wengue, Bay Sand, Storm Gray
- Work surfaces over 48" include a stiffener
- Work surface thickness: 28 mm., particle board work surfaces, edge banding 2 mm thickness.

GAR9314824
GAR9316024
GAR9316530
GAR9317224

47" x 24" x 1"
59" x 24" x 1"
64" x 24" x 1"
71" x 24" x 1"

ACCESSORIES

DESCRIPTION

CODE

DIMENSIONS

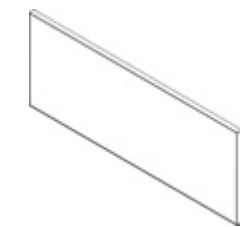

FABRIC SCREENS

- Colors (Reyna Fabric): Steel, Plumbago, Fog
- 27 mm. thickness
- No clamps included

GAH853050
GAH853090
GAH853120
GAH853150
GAH853180

18" x 12"
34" x 12"
46" x 12"
58" x 12"
70" x 12"

GAH854050
GAH854090
GAH854120
GAH854150
GAH854180

18" x 12"
34" x 12"
46" x 12"
58" x 12"
70" x 12"

GAH856090
GAH856120
GAH856150
GAH856180

34" x 12"
46" x 12"
58" x 12"
70" x 12"

GAH857090
GAH857120
GAH857150
GAH857180

34" x 12"
46" x 12"
58" x 12"
70" x 12"

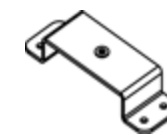

SCREEN BRACKET

- Colors: Black, Textured Aluminum

GAR849160

6" x 2"



RACEWAY BRACKET

- Colors: Black, Textured Aluminum

GAR840160

6" x 2"

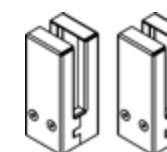

CLAMP

GAH-BTD

QUICK SHIP PRODUCTS

DESCRIPTION

CODE

DIMENSIONS



METAL BF PEDESTAL (MOBILE)

- Colors: White, Black, Textured Aluminum
- 1 drawer
- 1 file cabinet

GAH306030

15 x 18 x 22"

GAH306040

12 x 18 x 22"



DEAN

- 1 power
- 1 USB dual

BE04315-1-1A-A-120

120" cord

BE04315-1-1A-A-72

72" cord



MIKI

- White/Black color
- 1 power
- 1 USB A + 1 USB C

BE010017TR-1-1AC-EM-108

108" cord



MIKI

- White/Black color
- 2 power
- 1 USB A + 1 USB C

BE010017TR-2-1AC-EM-108

108" cord



REACH DUAL MONITOR ARM

GAC998MD



REACH SINGLE MONITOR ARM

GAC998MS

QUICK SHIP PRODUCTS

FINISHES AND TEXTURES WORKSURFACES

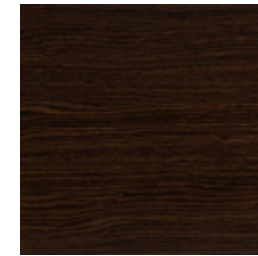

Wengue



Bay Sand



Storm Gray



White

PEDESTALS



Textured Aluminum



Black

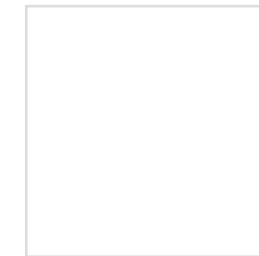

White

STRUCTURE



Textured Aluminum



Black

FINISHES & TEXTURES
WORKSURFACES



Wengue



Walnut

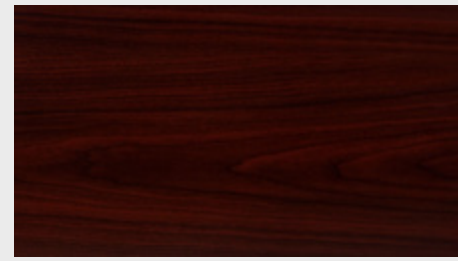

Cherry



Tamarind



Silver Apricot

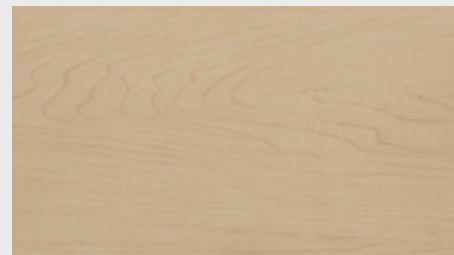

Maple

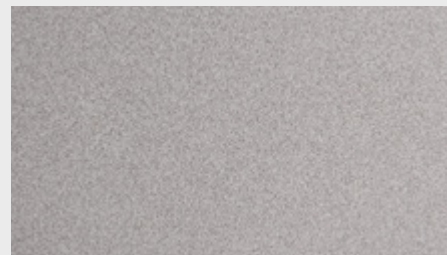

Nebula

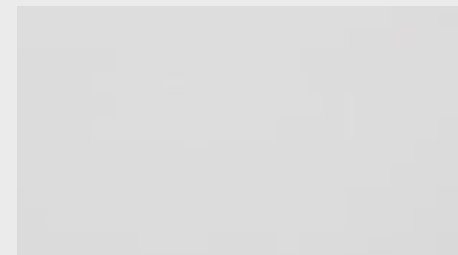

Platinum

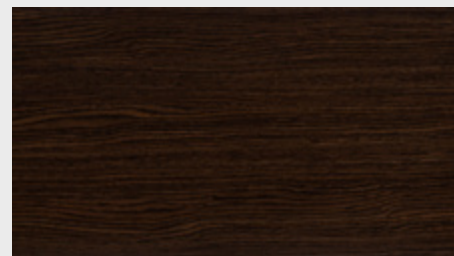

Wengue

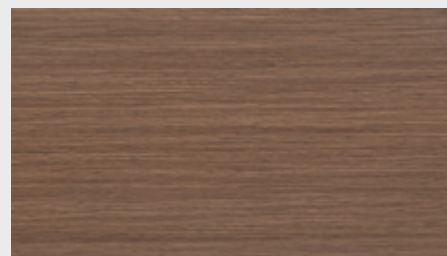

Spanish Oak

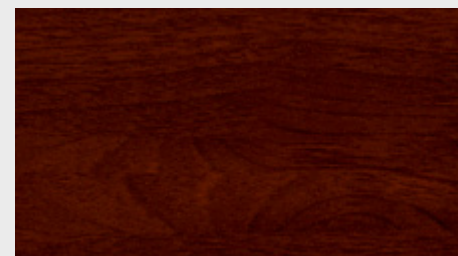

Mahogany



Silver

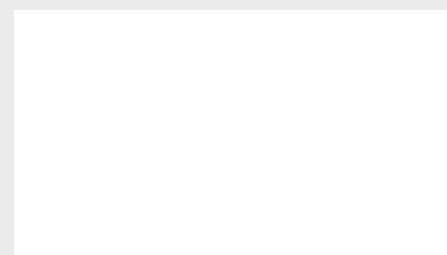

White

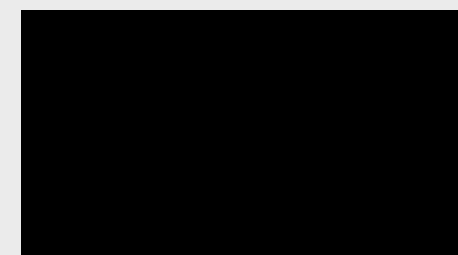

Black

Wood Veneer

FINISHES & TEXTURES
WORKSURFACES

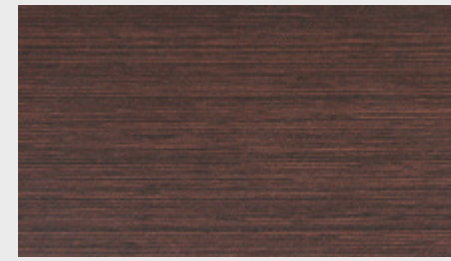

Wengue*



Spanish Oak

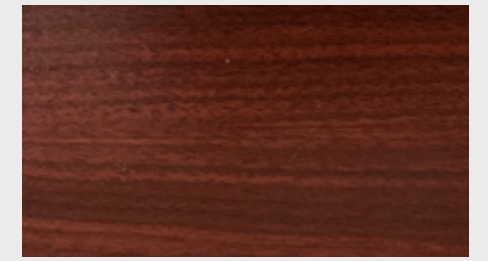

Cherry



Bordeaux

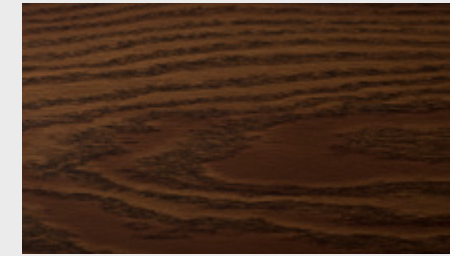

English Oak



Pear

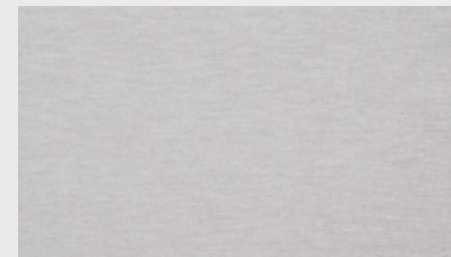

Silver

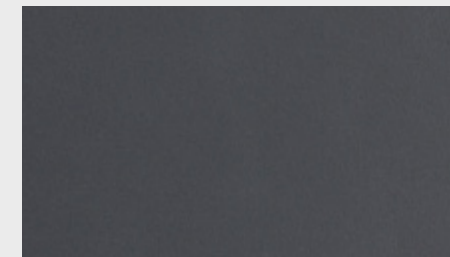

Oxford

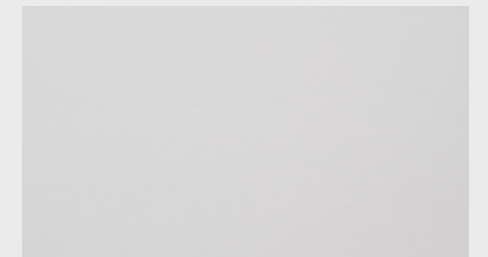

Platinum

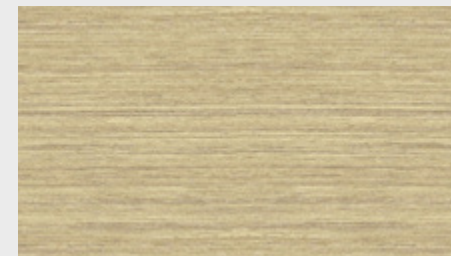

Bay Sand



Storm Gray

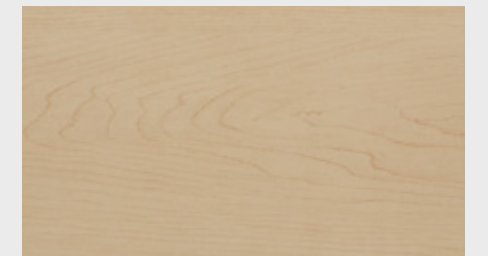

Maple

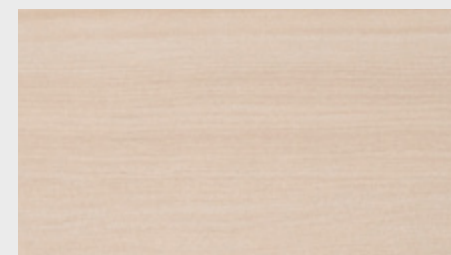

Anigre

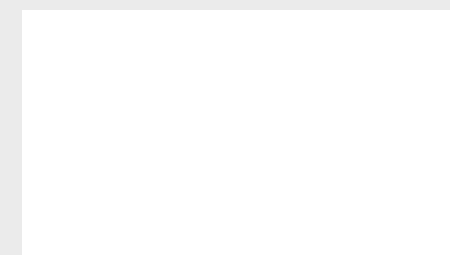

White

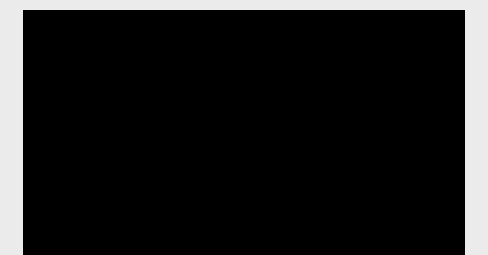

Black

**Quick Ship available / **Additional fabrics available
Color may vary from picture*

FINISHES & TEXTURES

BASES & BEAMS

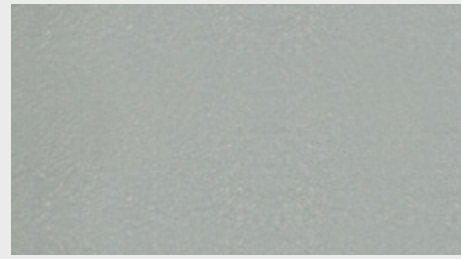

Textured Aluminum

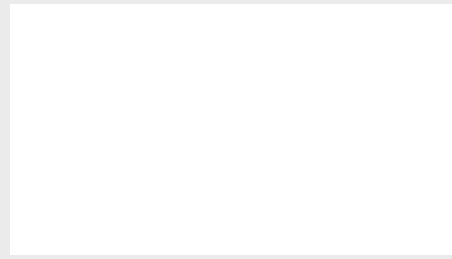

White



Black

— Powder Coating



Mist Adisson



Cappuchino Adisson



Red Adisson

SCREENS



Red



Green



Indigo

— Liquid Coating

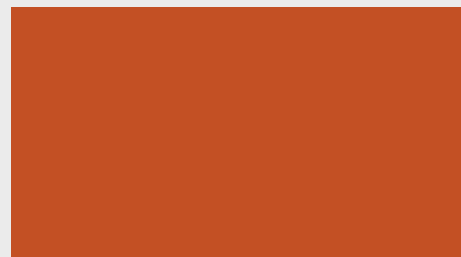

Orange

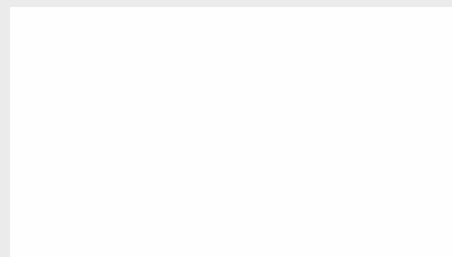

White

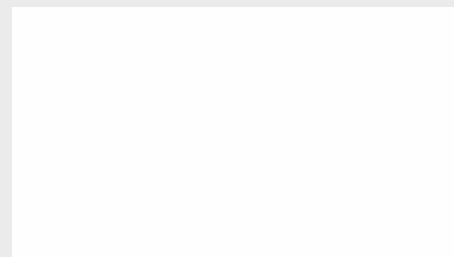

Whiteboard*



Shedron Adisson



Grape Adisson



Orange Adisson



Plumbago Adisson

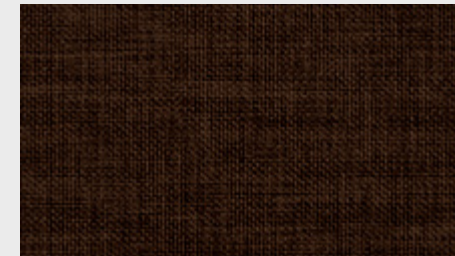

Tobacco Adisson

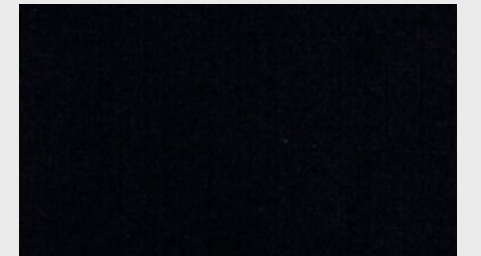

Lead Adisson

SCREENS & CUSHIONS



Fuchsia Adisson



Gray Adisson

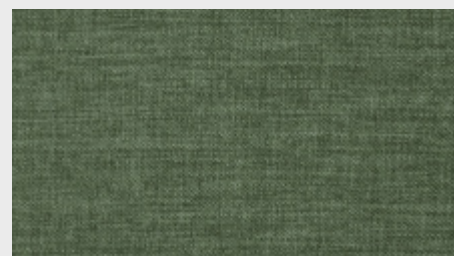

Nature Green Adisson

— Fabrics

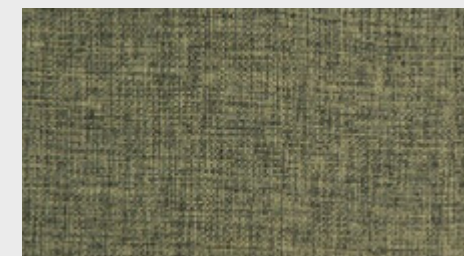

Green Adisson

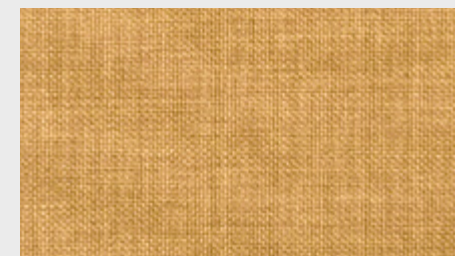

Mango Adisson

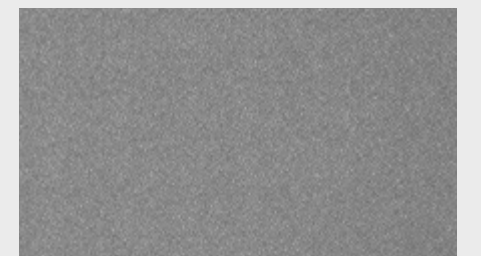

Steel Reyna*

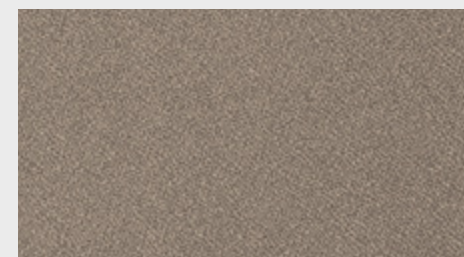

Fog Reyna

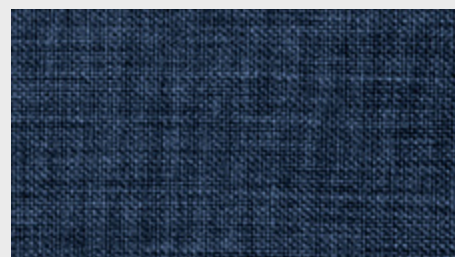

Plumbago Reyna

**Quick Ship available
Color may vary from picture*

Gebesa
CREATING AMAZING SPACES