



Gebesa | CREATING AMAZING SPACES

START

4

Start

14

Typicals

15

Accessories

16

Quick Ship

20

Finishes and Textures



## START

Start allows you to maximize your space and your budget, offering the best combination of design, quality and price. Thanks to minimal components, Start is easy to install. It is also easy to expand, allowing for a large number of combinations to meet any space-planning need with customized configurations and high aesthetic value.

Optimize and save space with the strategic positioning of surfaces and bases as you elevate the functionality of each work area with accessories to enhance your work experience.

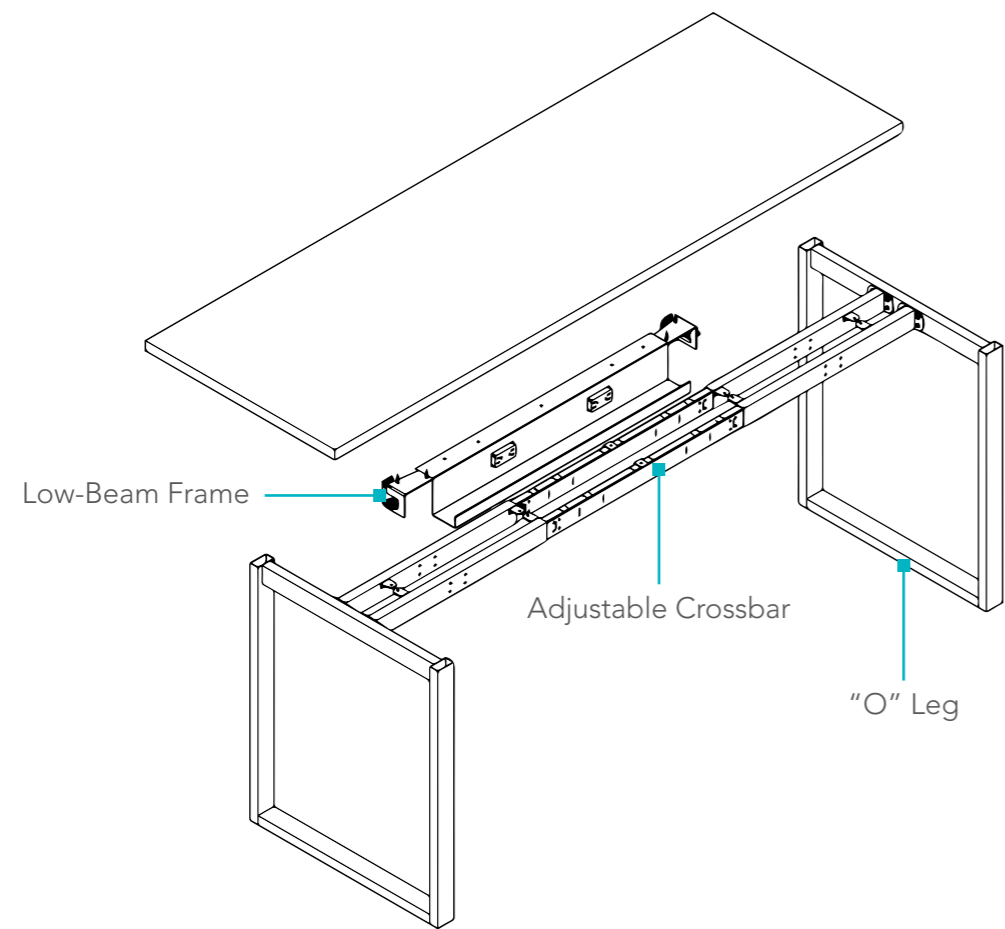

## SINGLE RUN

Optimize space in linear configuration with a single run system that offers hidden electrical access for voice and data.



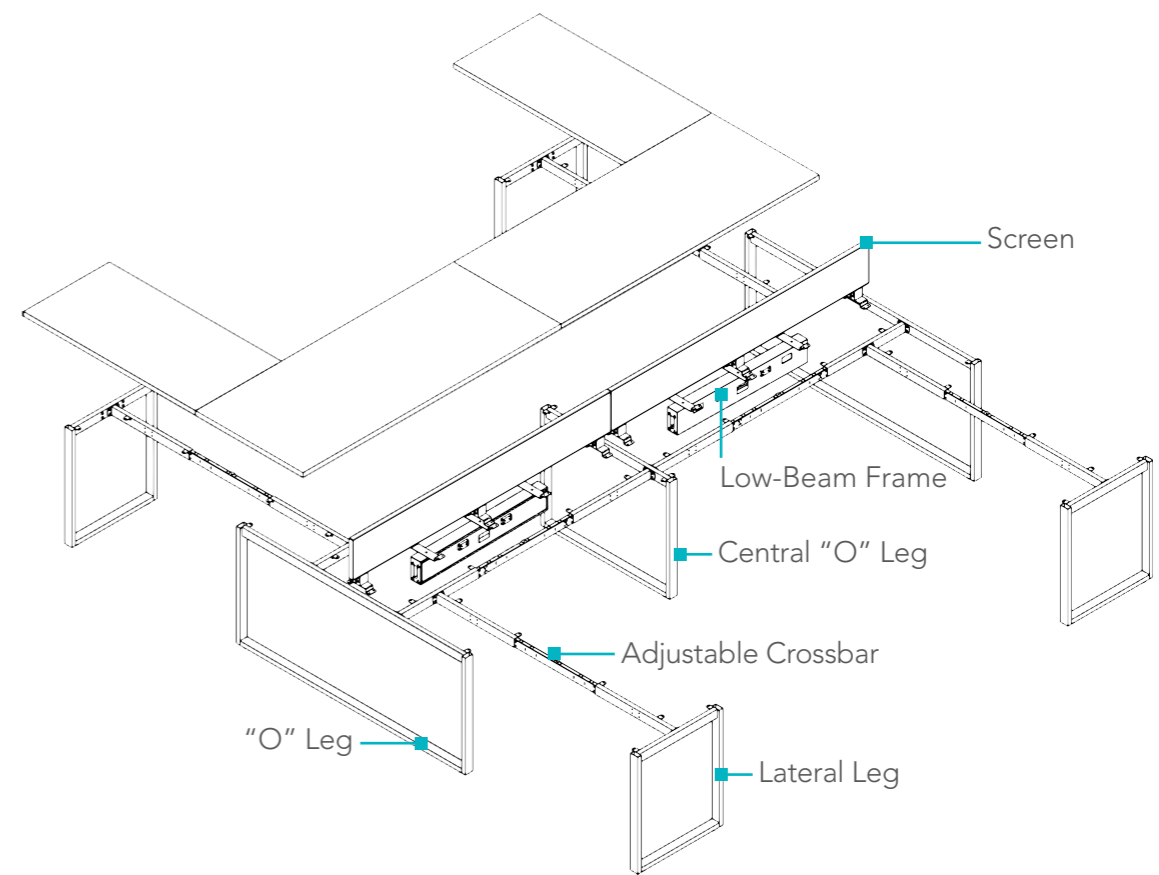

## DOUBLE RUN

Start is perfect for the optimization and expansion of space and resources in offices with large work teams. With benching and double run systems, each workstation can adapt to technology demands with electrical access to voice and data in both directions.

# THE KEY TO ADAPTABILITY

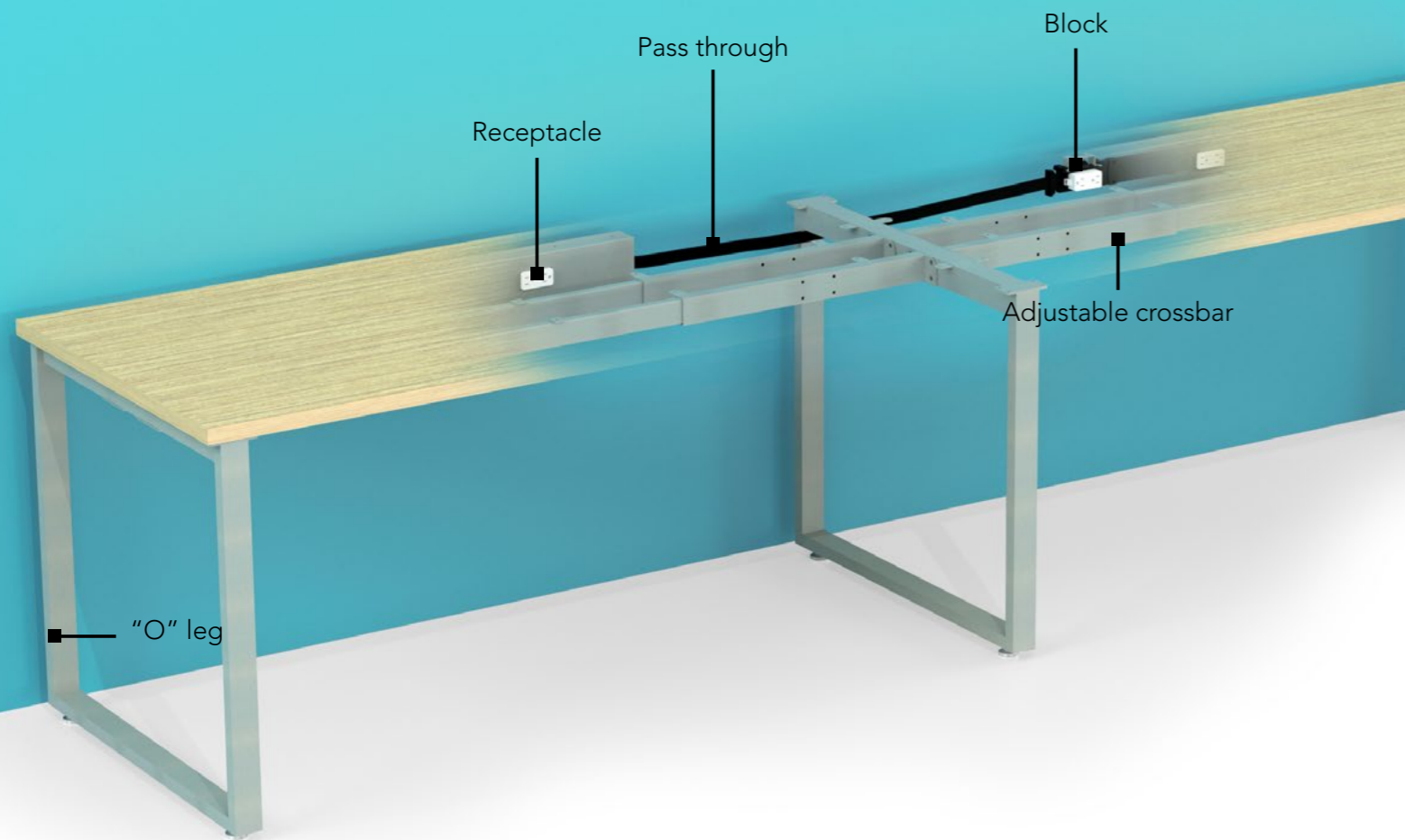

Thanks to the flexibility of Start, adapting to change is easier than ever.

Optimize responsiveness to changes in configurations. Go from a single run to a double run system to accommodate increases in work staff and the overall growth of your organization.

Adapt basic workstations to benching with a quick change of covers and repositioning of the adjustable crossbar. Add bases to increase the number of stations.



## BASE

Adapt your work area's dimensions and design with Start's various base options, including central, "O" and side legs, along with adjustable crossbar, ducts and gutters. For metal body colors, choose among black, white, textured aluminum and RM Gray.

## ADJUSTABLE CROSSBAR

**Base finishes:**  
Black, White, RM Gray,  
Textured Aluminum

**Height (with top):**  
30"

**Adjustable crossbar:**  
For configurations from 48°  
to 72°

**Warranty:**  
10 years

**Electrification:**  
Optional

**Work surface widths:**  
48", 60", 66" and 72"

**Work surface depths:**  
24" and 30"

## ADJUSTABLE CROSSBAR

The adjustable crossbar lends stability to your furniture and reinforces the cover. It can expand to the size of the stringer, thanks to a design that opens and closes as needed.

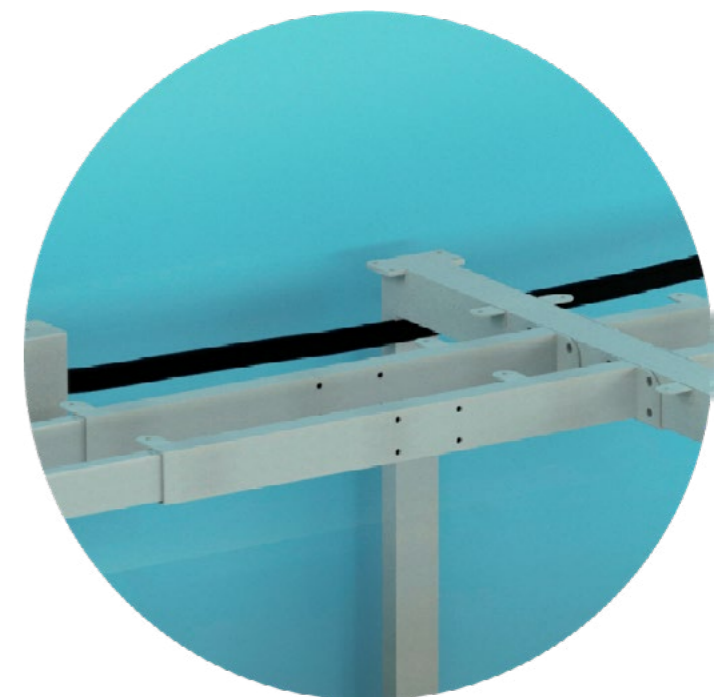



## BEAM

### Beam Power & Data Distribution System

Beam's flexible design keeps cables hidden, providing electrification in each station through knockouts, harnesses and ducts under covers. Choose the Beam benching version for double run configurations with users on both sides or single run for individual stations.

# TYPICALS

2-USER



Option A



Option B



Option I

3-USER



Option C

4-USER



Option D



Option E

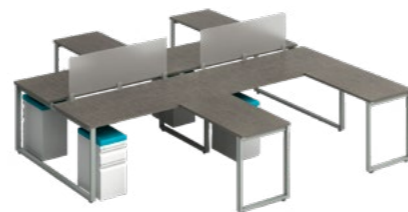

Option F

6-USER

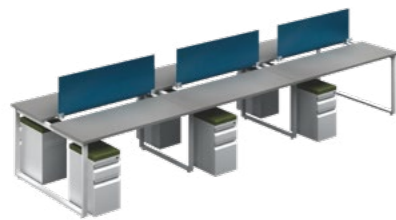

Option G



Option H

## SCREENS AND CLAMPS



Fabrics



Acrylic

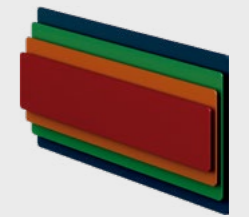

MDF

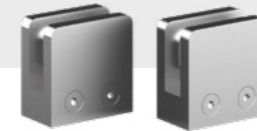

Clamps



Screen Holder



Metal Freestanding Screen

## ORGANIZATION / MOUNTING



Monitor Arms



Vertebrae



Power Data



Soft Cable Management

## STORAGE



Metal Pedestals  
12" and 15"

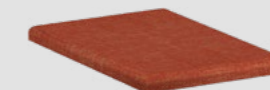

Pedestal Cushion



Metal Pedestals with Laminate Top





## QUICK SHIP PRODUCTS

### BASES

DESCRIPTION

CODE

DIMENSIONS

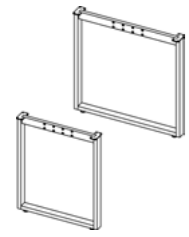

#### LATERAL LEGS

- Colors: Black, Textured Aluminum
- Single run
- For Start work surface only

**GAR826060**

24" x 28"

**GAR826075**

30" x 28"



#### "O" LEG

- Colors: Black, Textured Aluminum
- Double run
- For 24" and 30" work surfaces
- For Start work surface only

**GAR825130**

52" x 28"

**GAR825160**

63" x 28"



#### CENTRAL LEG DOUBLE RUN

- Colors: Black, Textured Aluminum
- Single and double run

**GAR827090**

36 x 28"



#### ADJUSTABLE CROSSBAR

- Colors: Black, Textured Aluminum
- Single run
- For Start work surface only

**GAR867010**

Adjustable from  
42" to 72"

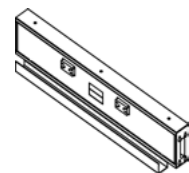

#### BENCHING BEAM

- Colors: Black, Textured Aluminum

**GAH839090**

34" x 2.75" x 6"

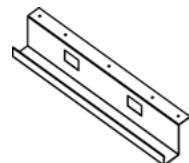

#### BENCHING BEAM SINGLE RUN

- Colors: Black, Textured Aluminum

**GAR841075**

29" x 4" x 5"

## QUICK SHIP PRODUCTS

### SURFACES

DESCRIPTION

CODE

DIMENSIONS

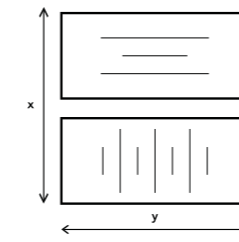

Horizontal (H) Vertical (V)

Width (y) x Depth (x) x  
Thickness (z)

#### STRAIGHT WORK SURFACE

- Colors: White, Wengue, Bay Sand, Storm Gray
- Work surfaces over 48" include a stiffener
- Work surface thickness: 28 mm., particle board work surfaces, edge banding 2 mm thickness.

**GAR9314824**  
**GAR9316024**  
**GAR9316530**  
**GAR9317224**

47" x 24" x 1"  
59" x 24" x 1"  
64" x 24" x 1"  
71" x 24" x 1"

### ACCESSORIES

DESCRIPTION

CODE

DIMENSIONS

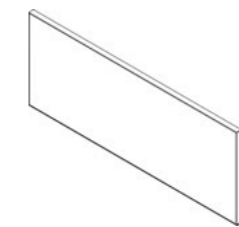

#### FABRIC SCREENS

- Colors (Reyna Fabric): Steel, Plumbago, Fog
- 27 mm. thickness
- No clamps included

**GAH853050**  
**GAH853090**  
**GAH853120**  
**GAH853150**  
**GAH853180**

18" x 12"  
34" x 12"  
46" x 12"  
58" x 12"  
70" x 12"

**GAH854050**  
**GAH854090**  
**GAH854120**  
**GAH854150**  
**GAH854180**

18" x 12"  
34" x 12"  
46" x 12"  
58" x 12"  
70" x 12"

**GAH856090**  
**GAH856120**  
**GAH856150**  
**GAH856180**

34" x 12"  
46" x 12"  
58" x 12"  
70" x 12"

**GAH857090**  
**GAH857120**  
**GAH857150**  
**GAH857180**

34" x 12"  
46" x 12"  
58" x 12"  
70" x 12"

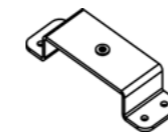

#### SCREEN BRACKET

- Colors: Black, Textured Aluminum

**GAR849160**

6" x 2"

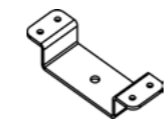

#### RACEWAY BRACKET

- Colors: Black, Textured Aluminum

**GAR840160**

6" x 2"

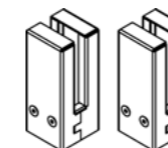

#### CLAMP

**GAH-BTD**

## QUICK SHIP PRODUCTS

DESCRIPTION

CODE

DIMENSIONS



### METAL BF PEDESTAL (MOBILE)

- Colors: White, Black, Textured Aluminum
- 1 drawer
- 1 file cabinet

**GAH306030**

15 x 18 x 22"

**GAH306040**

12 x 18 x 22"



### DEAN

- 1 power
- 1 USB dual

**BE04315-1-1A-A-120**

120" cord

**BE04315-1-1A-A-72**

72" cord



### MIKI

- White/Black color
- 1 power
- 1 USB A + 1 USB C

**BE010017TR-1-1AC-EM-108**

108" cord



### MIKI

- White/Black color
- 2 power
- 1 USB A + 1 USB C

**BE010017TR-2-1AC-EM-108**

108" cord



### REACH DUAL MONITOR ARM

**GAC998MD**



### REACH SINGLE MONITOR ARM

**GAC998MS**

## QUICK SHIP PRODUCTS

### FINISHES AND TEXTURES WORKSURFACES

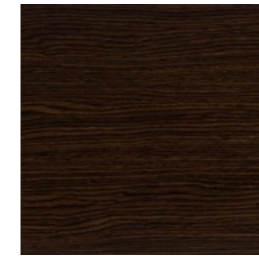

Wengue



Bay Sand



Storm Gray

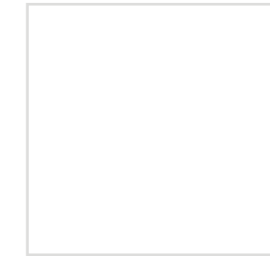

White

### PEDESTALS



Textured Aluminum



Black

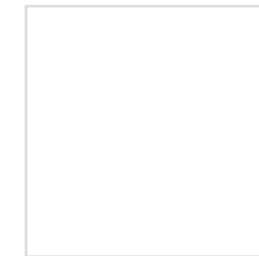

White

### STRUCTURE

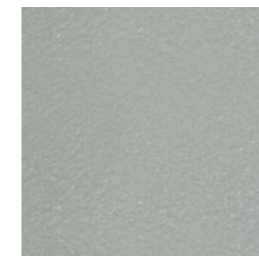

Textured Aluminum



Black

**FINISHES & TEXTURES  
WORKSURFACES**

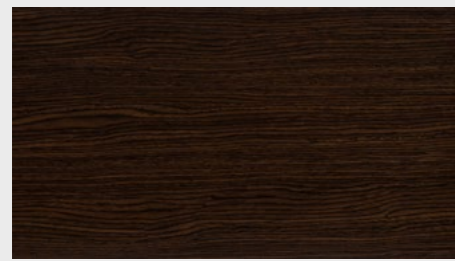

Wengue

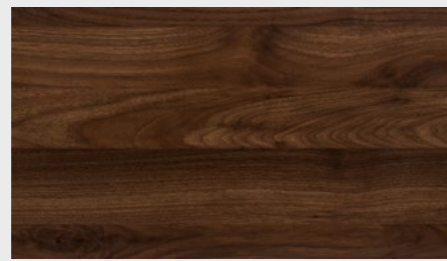

Walnut

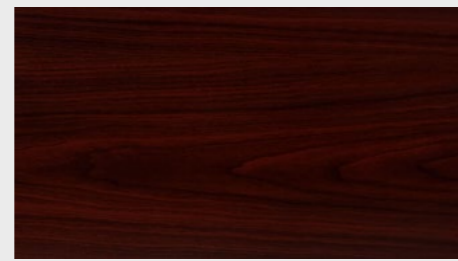

Cherry

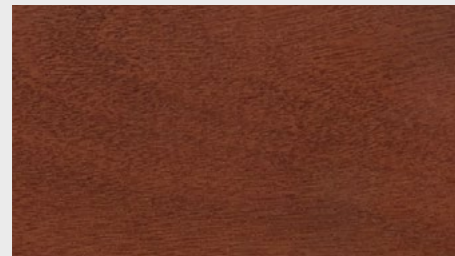

Tamarind

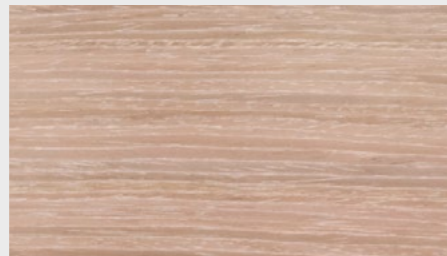

Silver Apricot

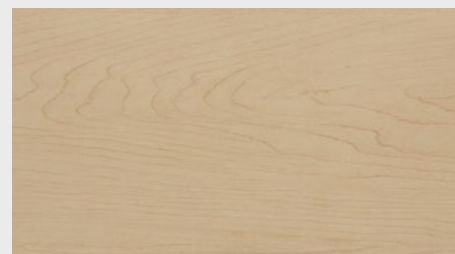

Maple

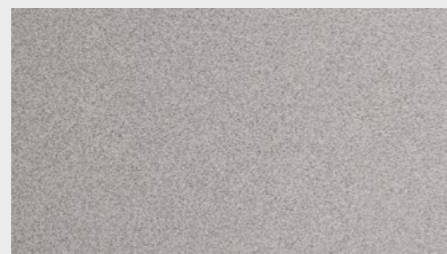

Nebula

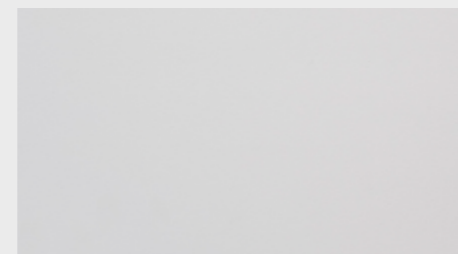

Platinum

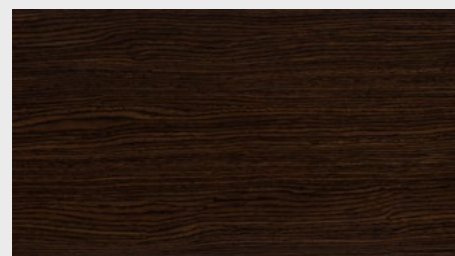

Wengue



Spanish Oak

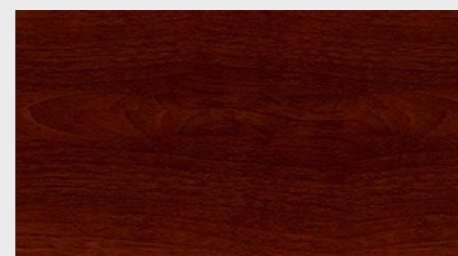

Mahogany



Silver

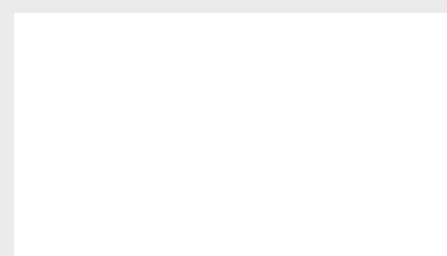

White

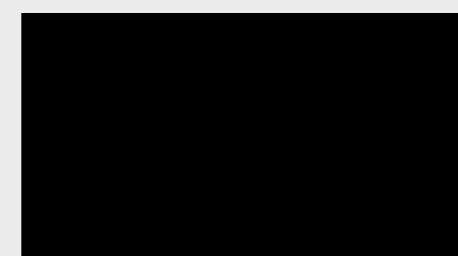

Black

Wood Veneer

**FINISHES & TEXTURES  
WORKSURFACES**



Wengue\*



Spanish Oak

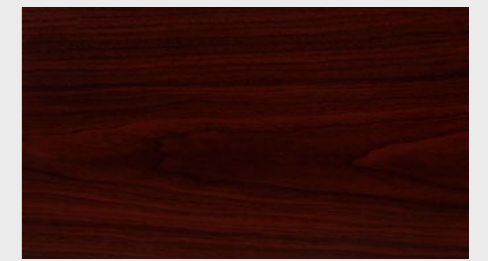

Cherry

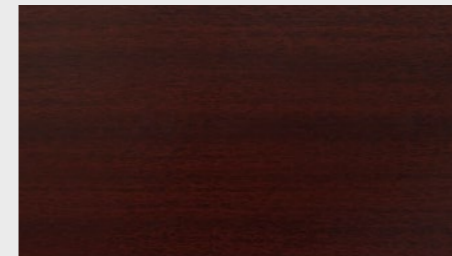

Bordeaux

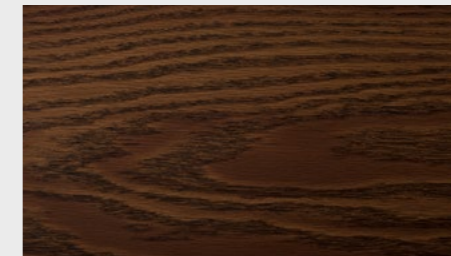

English Oak

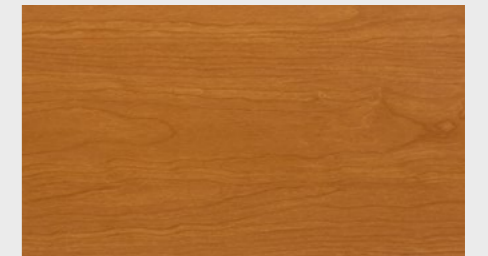

Pear



Silver

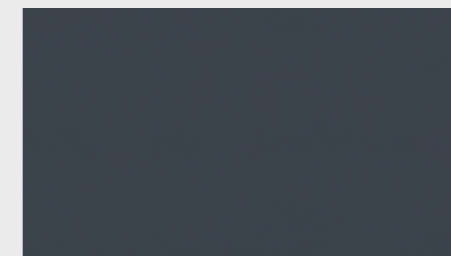

Oxford

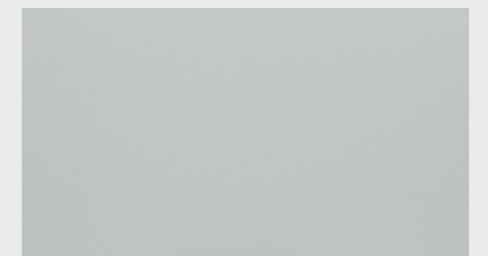

Platinum

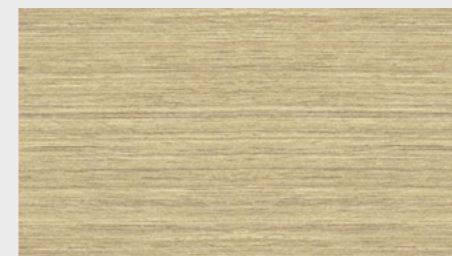

Bay Sand



Storm Gray

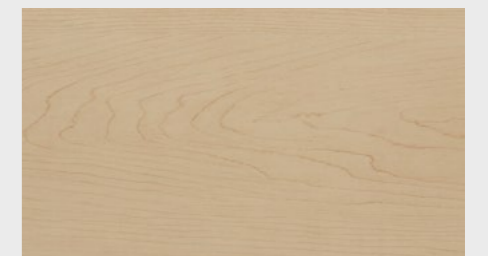

Maple



Anigre

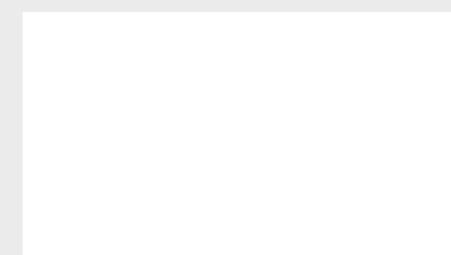

White

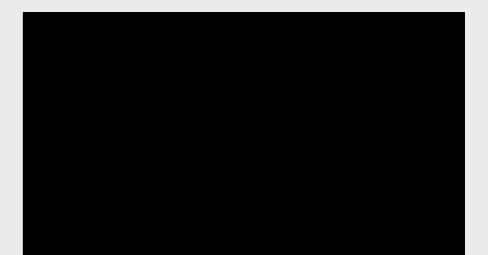

Black

Low-Pressure Laminate

*\*Quick Ship available / \*\*Additional fabrics available  
Color may vary from picture*

# FINISHES & TEXTURES

## BASES & BEAMS



Textured Aluminum

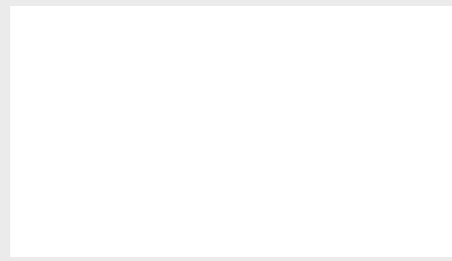

White



Black

### — Powder Coating



Mist Adisson



Cappuchino Adisson



Red Adisson

## SCREENS



Red



Green



Indigo

### — Liquid Coating

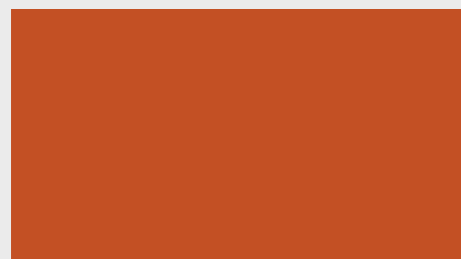

Orange

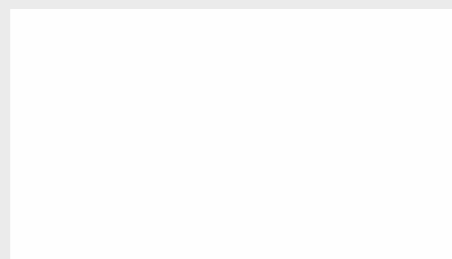

White

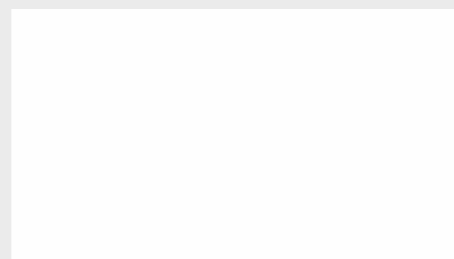

Whiteboard\*



Shedron Adisson



Grape Adisson



Orange Adisson



Plumbago Adisson

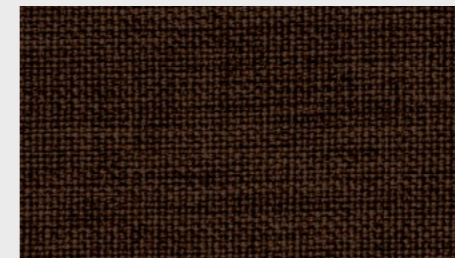

Tobacco Adisson

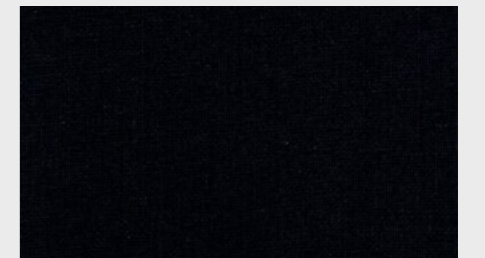

Lead Adisson

## SCREENS & CUSHIONS

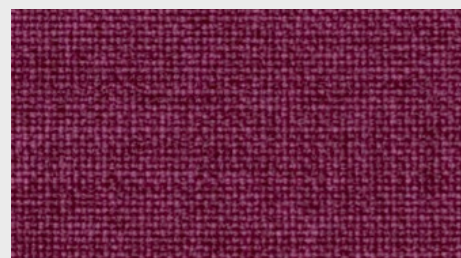

Fuchsia Adisson

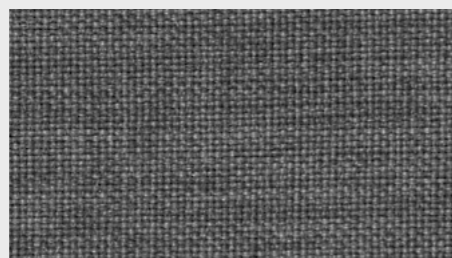

Gray Adisson



Nature Green Adisson

### — Fabrics



Green Adisson



Mango Adisson

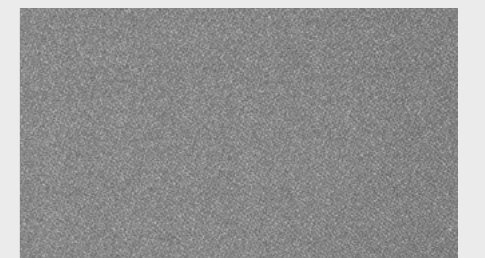

Steel Reyna\*

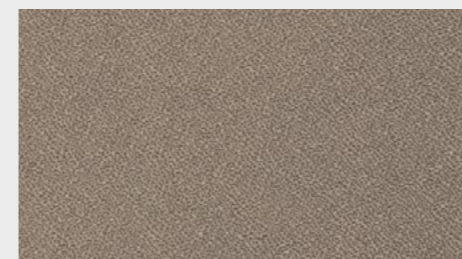

Fog Reyna



Plumbago Reyna

*\*Quick Ship available  
Color may vary from picture*

**Gebesa**  
CREATING AMAZING SPACES