



Gebeso | CREATING AMAZING SPACES

ELITE

6

STRUCTURE

12

GALLERY
PANELS

14

WORKSURFACES

16

PEDESTALS

18

FILING AND
STORAGE

20

MOUNTING
TILES

22

ACCESSORIES

24

POWER AND
DATA

26

DIMENSIONS

35

FINISHES

Furniture color may vary from renderings.

ELITE

Created engineering and technology principles, Elite has a full voice, data, and power conductivity capacity. It allows you to design workspaces with style thanks to total flexibility in finishes and materials. Its design adapts to each space and can be replicated in all directions.

Adapt each segment and create dividing combinations with single, double, triple, or quadruple panels and the same or different finishes every 10". Project the entire personality of your organization. At the same time, it adapts to your work team and uses other devices with its power capabilities. It gives each station privacy and saves linear space.

ELITE

STRUCTURE

ELITE

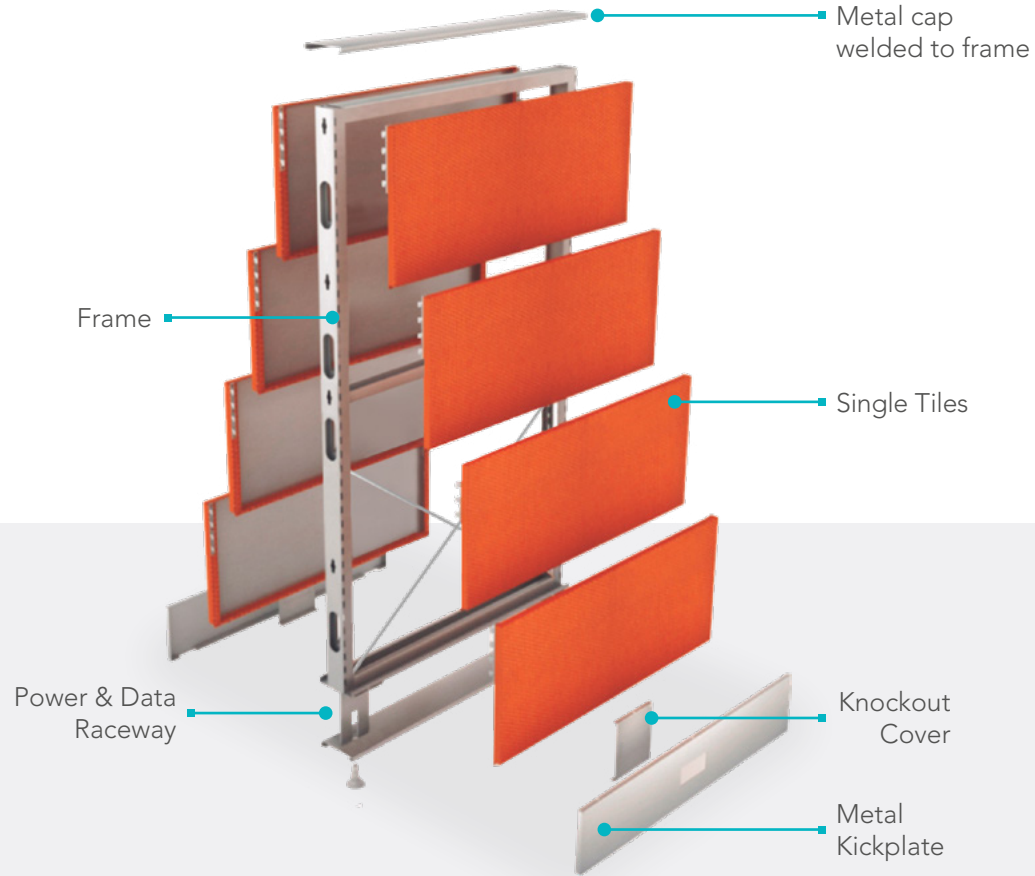

Furniture color may vary from renderings.

You dream it, We'll make it!

The structure of the Elite panel has a tile system on both sides. Its total thickness is 3", and it has a frame in steel sheet, with posts that allow the union between panels to mount your modular system. Its inner part has a metal duct with a lid, which helps electrification. Bring to reality the office design you dreamed of!

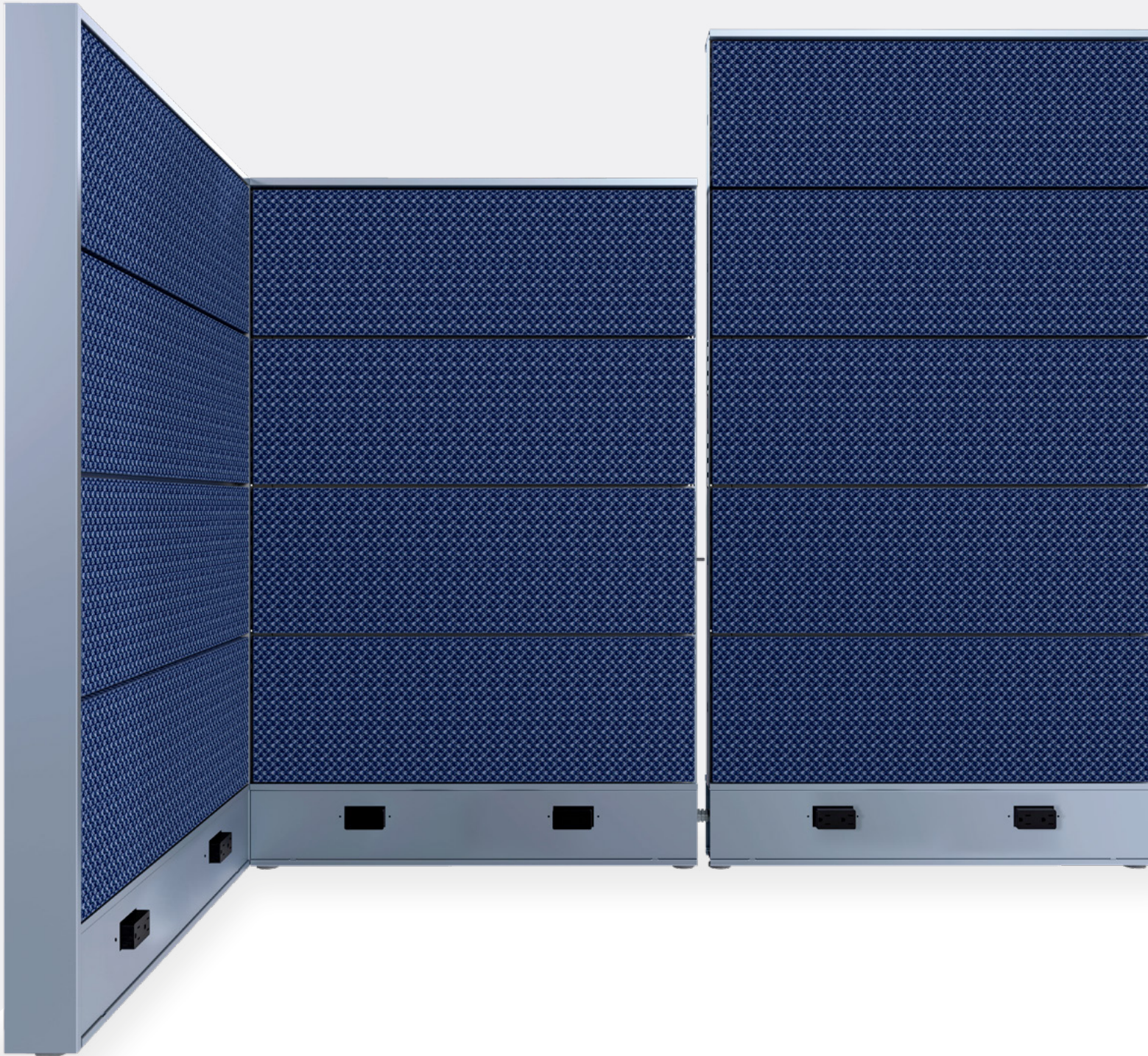

Conduction far & wide

Created under engineering and technology principles, Elite has full voice and data driving capacity, as well as electrification through harnesses, passing along the lower metal duct.

Perfect assembly

With the Bolt assembly, the Elite fixing points allows you to put each panel together providing a high firmness value, so you can perform your tasks without worries.

Bolt Assembly

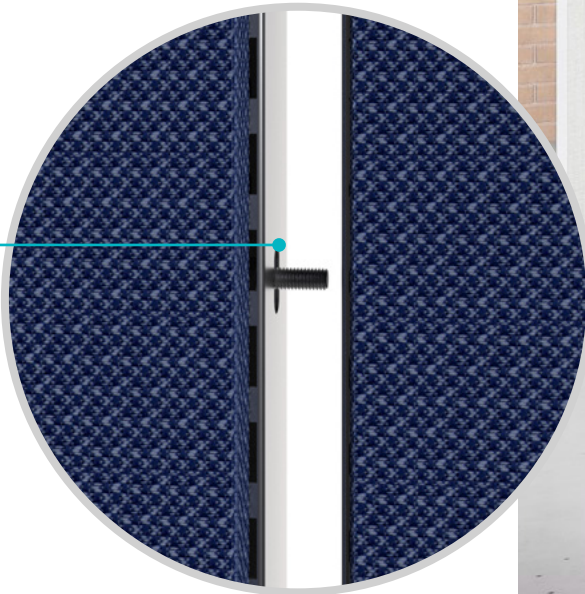

GALLERY PANELS

ELITE

A NEW LEVEL OF PERSONALIZATION OF SPACES!

Gallery Panels are an affordable, elegant, and practical way to incorporate separation and privacy into your panel system configuration. Customize your environment with a wide variety of low-pressure finishes.

Our Gallery Panels can be attached to create divisions, through junctions with the panels, or at the end of a configuration - redefines the boundaries of a workspace.

CONFIGURATIONS



"L" Configuration



"T" Configuration



"Y" Configuration



"X" Configuration



Panel



Gallery Panel



Furniture color may vary from renderings.

WORKSURFACES

ELITE

Furniture color may vary from renderings.



Straight



Transition - Curved



Transition - Straight



Corner - Curved



Corner - Straight



Bullet



Hatchet



Peninsula



"P" Top



Irregular



End



Boomerang



1/4 Round



Half-Round



Transaction Counter



PEDESTALS

ELITE



File/File
Metallic Pedestal



Box/Box/File
Metallic Pedestal



LPL, HPL, Veneer
Pedestal

HANDLES (For LPL, HPL, or VENEER pedestal fronts)

Standard Handles



Platinum Black

Additional Handle Options



Kenza Spazio Senior Millenium



FILING AND STORAGE

ELITE



LATERAL FILES



Global 2-drawer metal lateral file



Metal combo file

STORAGE CABINETS



Laminate and Veneer Fronts



Metal Structure

OVERHEAD

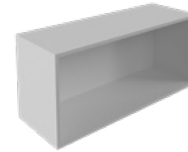

Open Overhead



Overhead with Flipper Door

The overheads can be:

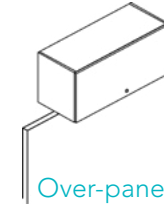

Over-panel

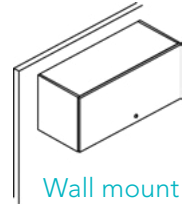

Wall mount

MOUNTING TILES

ELITE

Furniture color may vary from renderings.



WHITEBOARD MOUNTING TILE

Install our paint patch on the screens of your Elite modular system and exchange ideas between collaborators and write down notes, issues or info.



MOUNTING TILE

Create an optimal base for other accessories to be fastened such as a vase holder or pen. Our panel achieves the right conditions for all elements to have their place.

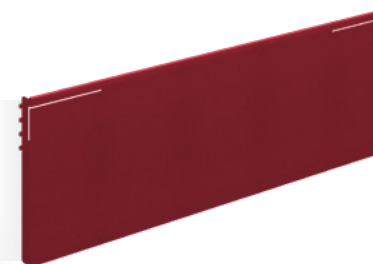

Furniture color may vary from renderings.



ACCESSORIES

ELITE

- 1.- POST EXTENSION TO CEILING FOR ELECTRICAL
- 2.- END CAPS

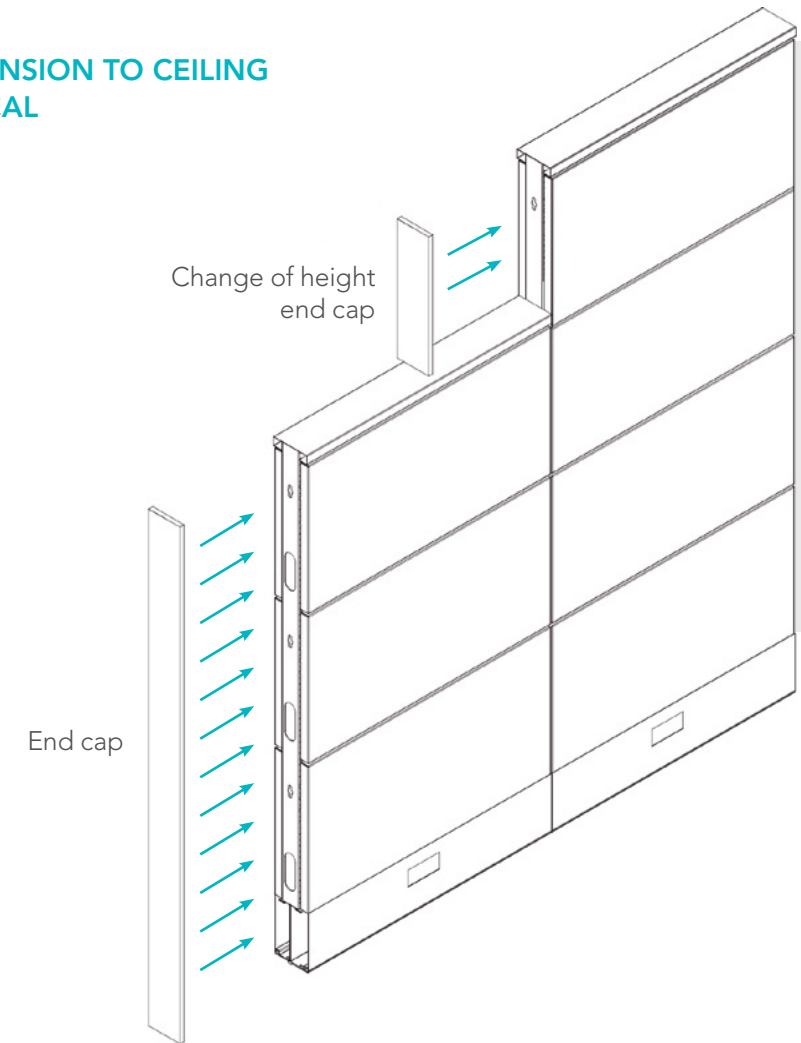

POWER AND DATA

ELITE

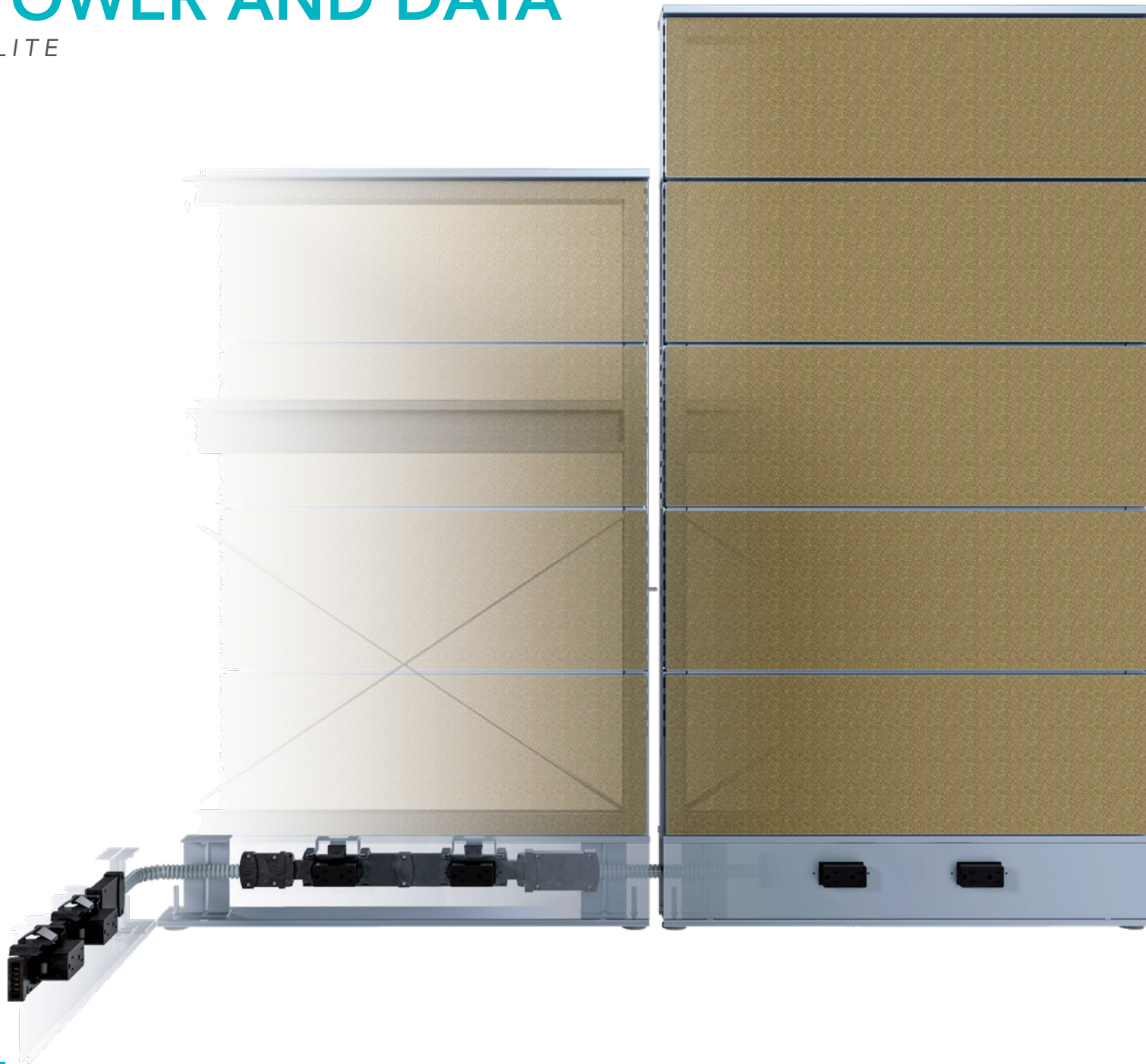

- **8-Trac:** Height F / "Y" Dimension 1.500 / "Z" Dimension 3.39
- **Phase 3:** Height G / "Y" Dimension 1.625 / "Z" Dimension 3.64

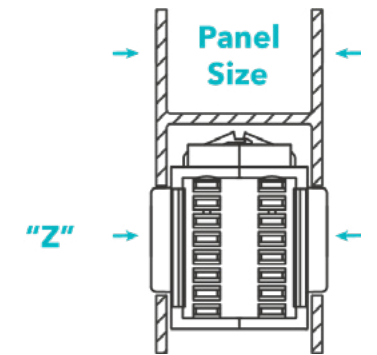
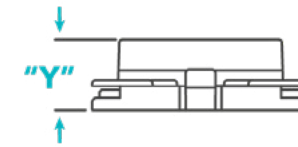

DIMENSIONS

ELITE

Note: Depth and width shown in nominal dimensions.

FRAME STRUCTURE (Height 35" (90 cm) / 3.15" depth / Single Tiles (10") 3 per side, 6 total)

W: 18" (45 cm) | 24" (60 cm) | 30" (75 cm) | 36" (90 cm) | 42" (105 cm) | 48" (120 cm) | 60" (150 cm)

FRAME STRUCTURE (Height 45" (115 cm) / 3.15" depth / Single Tiles (10") 4 per side, 8 total)

W: 18" (45 cm) | 24" (60 cm) | 30" (75 cm) | 36" (90 cm) | 42" (105 cm) | 48" (120 cm) | 60" (150 cm)

FRAME STRUCTURE (Height 55" (140 cm) / 3.15" depth / Single Tiles (10") 5 per side, 10 total)

W: 18" (45 cm) | 24" (60 cm) | 30" (75 cm) | 36" (90 cm) | 42" (105 cm) | 48" (120 cm) | 60" (150 cm)

FRAME STRUCTURE (Height 65" (165 cm) / 3.15" depth / Single Tiles (10") 6 per side, 12 total)

W: 18" (45 cm) | 24" (60 cm) | 30" (75 cm) | 36" (90 cm) | 42" (105 cm) | 48" (120 cm) | 60" (150 cm)

FRAME STRUCTURE (Height 75" (190 cm) / 3.15" depth / Single Tiles (10") 7 per side, 14 total)

W: 18" (45 cm) | 24" (60 cm) | 30" (75 cm) | 36" (90 cm) | 42" (105 cm) | 48" (120 cm) | 60" (150 cm)

FRAME STRUCTURE (Height 85" (215 cm) / 3.15" depth / Single Tiles (10") 8 per side, 16 total)

W: 18" (45 cm) | 24" (60 cm) | 30" (75 cm) | 36" (90 cm) | 42" (105 cm) | 48" (120 cm) | 60" (150 cm)

KNOCKOUTS PER PANEL

18" (1) | 24" (1) | 30" (2) | 36" (2) | 42" (2) | 48" (2) | 60" (2)

FRAME CONNECTOR (3.15" x 3.15")

35" (90 cm) | 45" (115 cm) | 55" (140 cm) | 65" (165 cm) | 75" (190 cm) | 85" (215 cm)

POWER POLE FOR CONNECTOR

10" (25 cm) | 30" (75 cm) | 50" (125 cm) | 70" (175 cm) | 90" (225 cm)

END CAPS

35" (90 cm) | 45" (115 cm) | 55" (140 cm) | 65" (165 cm) | 75" (190 cm) | 85" (215 cm)

CHANGE OF THE END CAP

10" (25 cm) | 20" (50 cm) | 30" (75 cm) | 40" (100 cm) | 50" (125 cm)

GALLERY PANELS - "L", "T" CONFIGURATION - 35"

24 x 35" | 30 x 35" | 36 x 35" | 42 x 35" | 48 x 35" | 60 x 35" | 72 x 35"

GALLERY PANELS - "L", "T" CONFIGURATION - 45"

24 x 45" | 30 x 45" | 36 x 45" | 42 x 45" | 48 x 45" | 60 x 45" | 72 x 45"

GALLERY PANELS - "L", "T" CONFIGURATION - 55"

24 x 55" | 30 x 55" | 36 x 55" | 42 x 55"

DIMENSIONS

ELITE

Note: Depth and width shown in nominal dimensions.

GALLERY PANEL - "Y", "X" CONFIGURATION - 35"

48" x 35" | 60" x 35" | 72" x 35" | 85" x 35"

GALLERY PANEL - "Y", "X" CONFIGURATION - 45"

48" x 45" | 60" x 45" | 72" x 45" | 85" x 45"

STRAIGHT WORKSURFACES (Depths 24" (60 cm) / 30" (75 cm))

18" (45 cm) | 24" (60 cm) | 30" (75 cm) | 36" (90 cm) | 42" (105 cm) | 48" (120 cm) | 60" (150 cm) | 72" (180 cm)

TRANSITION - CURVED (Depth 30" (75 cm) / Connection (Z) 24" (60 cm))

W: 30" (75 cm) | 36" (90 cm) | 42" (105 cm) | 48" (120 cm) | 60" (150 cm) | 72" (180 cm)

TRANSITION - STRAIGHT (Depth 30" (75 cm) / Connection (Z) 24" (60 cm))

W: 30" (75 cm) | 36" (90 cm) | 42" (105 cm) | 48" (120 cm) | 60" (150 cm) | 72" (180 cm)

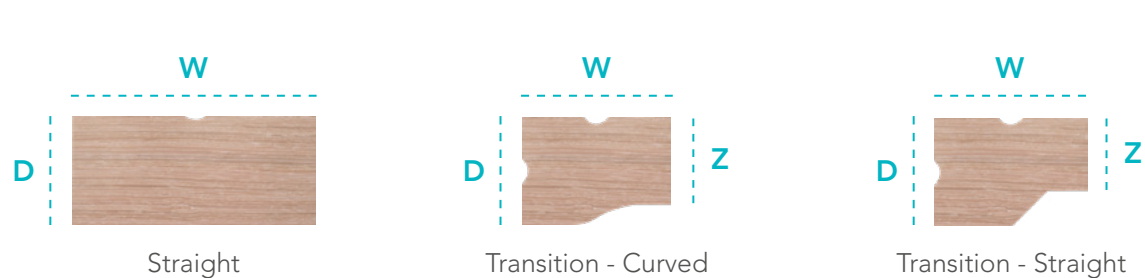

CORNER (CURVED AND STRAIGHT) WORKSURFACE (D x W x Z)

36" (90 cm) x 36" (90 cm) x 24" (60 cm) | 36" (90 cm) x 42" (105 cm) x 24" (60 cm)
48" (120 cm) x 36" (90 cm) x 24" (60 cm) | 42" (105 cm) x 42" (105 cm) x 24" (60 cm)
42" (105 cm) x 42" (105 cm) x 30" (75 cm) | 48" (120 cm) x 42" (105 cm) x 24" (60 cm)
48" (120 cm) x 42" (105 cm) x 30" (75 cm) | 60" (150 cm) x 36" (90 cm) x 24" (60 cm)
48" (120 cm) x 48" (120 cm) x 24" (60 cm) | 48" (120 cm) x 48" (120 cm) x 30" (75 cm)
60" (150 cm) x 42" (105 cm) x 24" (60 cm) | 60" (150 cm) x 42" (105 cm) x 30" (75 cm)
60" (150 cm) x 48" (120 cm) x 24" (60 cm) | 60" (150 cm) x 48" (120 cm) x 30" (75 cm)

BULLET WORKSURFACE (D x W)

24" (60 cm) x 60" (150 cm) | 24" (60 cm) x 65" (165 cm) | 24" (60 cm) x 72" (180 cm)
30" (75 cm) x 60" (150 cm) | 30" (75 cm) x 65" (165 cm) | 30" (75 cm) x 72" (180 cm)

HATCHET AND PENINSULA WORKSURFACES (D x W x Z)

36" (90 cm) x 72" (180 cm) x 24" (60 cm) | 36" (90 cm) x 72" (180 cm) x 30" (75 cm)

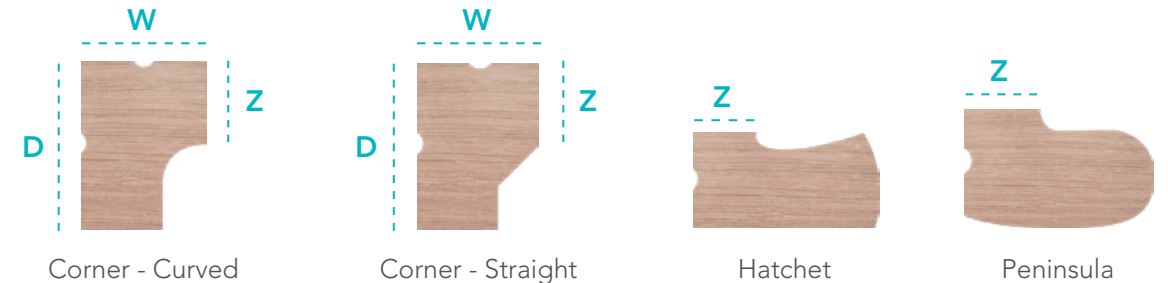

DIMENSIONS

ELITE

Note: Depth and width shown in nominal dimensions.

"P" TOP WORKSURFACE (D x W x Z)

36" (90 cm) x 72" (180 cm) x 30" (75 cm)

IRREGULAR WORKSURFACE (D x W x Z)

30" (75 cm) x 60" (150 cm) x 24" (60 cm) | 30" (75 cm) x 72" (180 cm) x 24" (60 cm)

30" (75 cm) x 72" (180 cm) x 30" (75 cm)

END WORKSURFACE (Depth 24" (60 cm))

24" (60 cm) | 30" (75 cm) | 36" (90 cm) | 42" (105 cm) | 48" (120 cm)

END WORKSURFACE (Depth 30" (75 cm))

24" (60 cm) | 30" (75 cm) | 36" (90 cm) | 42" (105 cm) | 48" (120 cm)

1/4 ROUND WORKSURFACE

24" (60 cm) x 24" (60 cm) | 30" (75 cm) x 30" (75 cm)

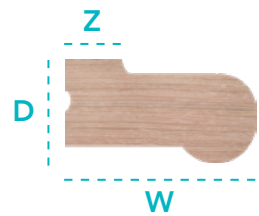

"P" Top

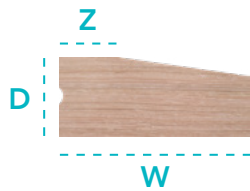

Irregular



End



1/4 round

BOOMERANG WORKSURFACE (D x W x Z)

24" (60 cm) x 42" (105 cm) x 24" (60 cm) | 24" (60 cm) x 42" (105 cm) x 30" (75 cm)

HALF-ROUND WORKSURFACE (D x W)

24" (60 cm) x 50.5" (128 cm) | 30" (75 cm) x 62.5" (158 cm)

TRANSACTION COUNTER - STRAIGHT WORKSURFACE (D x W)

14" (35 cm) x 24" (60 cm) | 14" (35 cm) x 30" (75 cm) | 14" (35 cm) x 36" (90 cm)

14" (35 cm) x 42" (105 cm) | 14" (35 cm) x 48" (120 cm) | 14" (35 cm) x 60" (150 cm)

TRANSACTION COUNTER - CORNER WORKSURFACE (D x W x Z)

43.5" (110 cm) x 43.5" (110 cm) x 14" (35 cm)

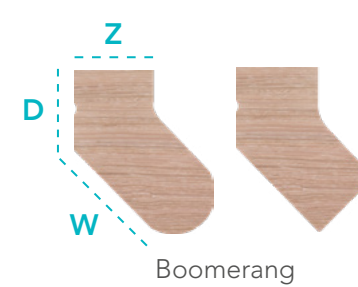

Boomerang

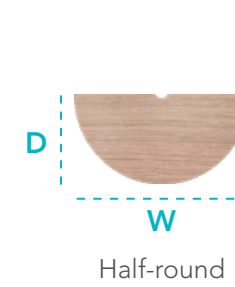

Half-round

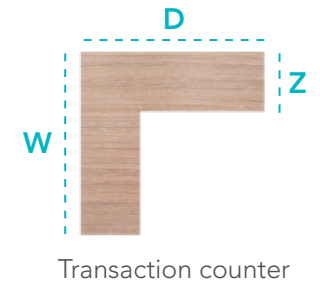

Transaction counter

DIMENSIONS

ELITE

TILES WIDTH (Height 10" (25 cm))

18" (45 cm) | 24" (60 cm) | 30" (75 cm) | 36" (90 cm) | 42" (105 cm) | 48" (120 cm) | 60" (150 cm)

TILES WIDTH (Height 20" (50 cm))

18" (45 cm) | 24" (60 cm) | 30" (75 cm) | 36" (90 cm) | 42" (105 cm) | 48" (120 cm) | 60" (150 cm)

TILES WIDTH (Height 30" (75 cm))

18" (45 cm) | 24" (60 cm) | 30" (75 cm) | 36" (90 cm) | 42" (105 cm) | 48" (120 cm) | 60" (150 cm)

TILES WIDTH (Height 40" (100 cm))

18" (45 cm) | 24" (60 cm) | 30" (75 cm) | 36" (90 cm) | 42" (105 cm) | 48" (120 cm) | 60" (150 cm)

Note: Depth and width shown in nominal dimensions.

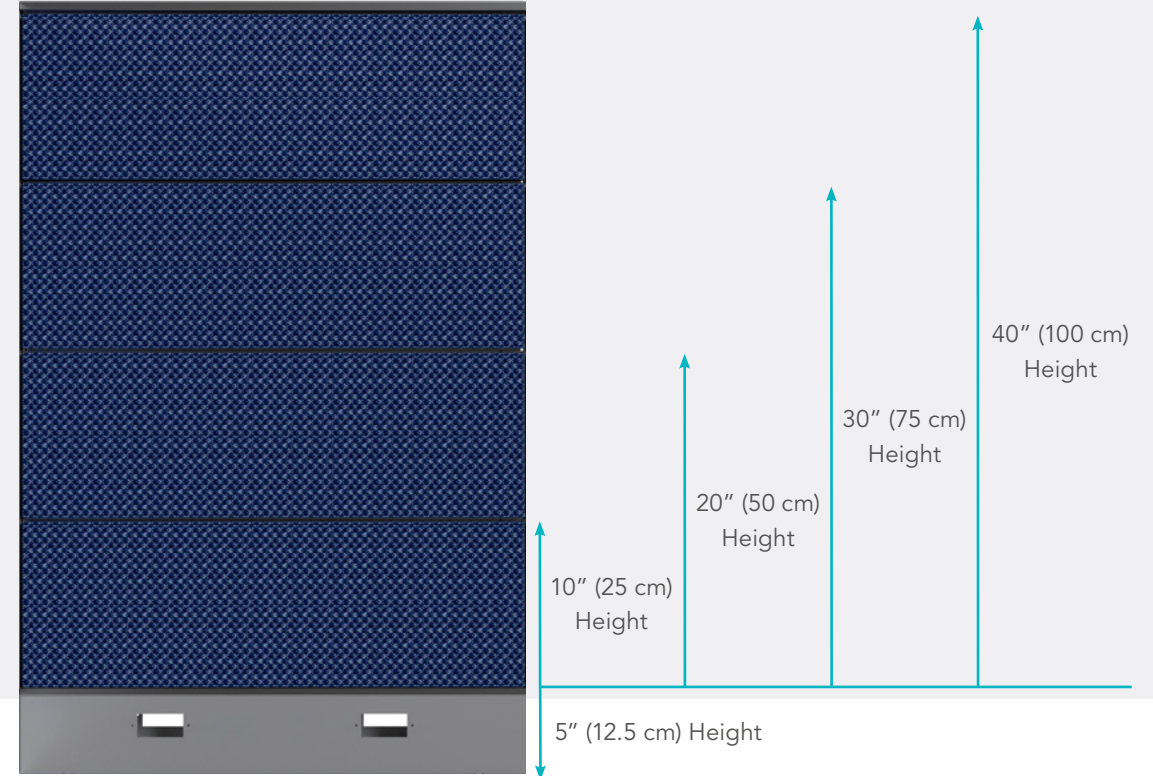

Note: Bottom 30 inches of frame cannot accommodate acrylic tiles due to cross-framing in panels. Acrylic tiles only available on tile placements above 35 inches.

Note: Tiles with knockouts available for data management.

PANELS FOR BOOKCASE

15" x 16" | 15" x 26" | 15" x 35" | 15" x 41"

MOUNTING TILES

24" x 10" | 30" x 10" | 36" x 10" | 42" x 10" | 48" x 10"

FILING AND STORAGE

- Pedestals: 16" x 23" x 29"
- Lateral File: 35" x 19" x 28"
- Combo file: 32" x 23" x 28"
- Storage Cabinets: 24 x 24 x 45" | 24 x 24 x 55" | 24 x 24 x 65" | 24 x 24 x 72"
- Shelves: 18" x 14" x 6" | 24" x 14" x 6" | 30" x 14" x 6" | 35" x 14" x 6" | 41" x 14" x 6" | 47" x 14" x 6"
- Overheads: 24" x 15" x 16" | 30" x 15" x 16" | 35" x 15" x 16" | 41" x 15" x 16" | 47" x 15" x 16"

GLASS SCREEN OVER TOP CAP (Height 10" (25 cm))

18" (45 cm) | 24" (60 cm) | 30" (75 cm) | 36" (90 cm) | 42" (105 cm) | 48" (120 cm) | 60" (150 cm)

FROSTED ACRYLIC DOORS (Kit)

65" | 75" | 85"

Note: Depth and width shown in nominal dimensions.

	WOOD VENEER	LOW PRESSURE	HIGH PRESSURE	WHITEBOARD	METAL	FABRIC	ACRYLIC
Elite Worksurfaces	•	•	•				
Elite Panels	•	•	•	•	•	•	•
Elite Structure					•		
Gallery Panels	•	•					
Metal Pedestals Structure					•		
Metal Pedestals Fronts	•	•	•		•		
Synergy Pedestals					•		
Shelves and Overheads	•	•	•		•		
Overhead - Flipper Door	•	•	•	•	•	•	
Cabinets Structure					•		
Cabinets Fronts	•	•			•		

LAMINATES

WOOD VENEER



LOW PRESSURE LAMINATES



Furniture color may vary from images.

HIGH PRESSURE LAMINATES



POWDER COATING



FABRICS

FABRIC GRADE A

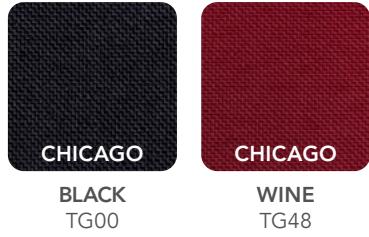

FABRIC GRADE B

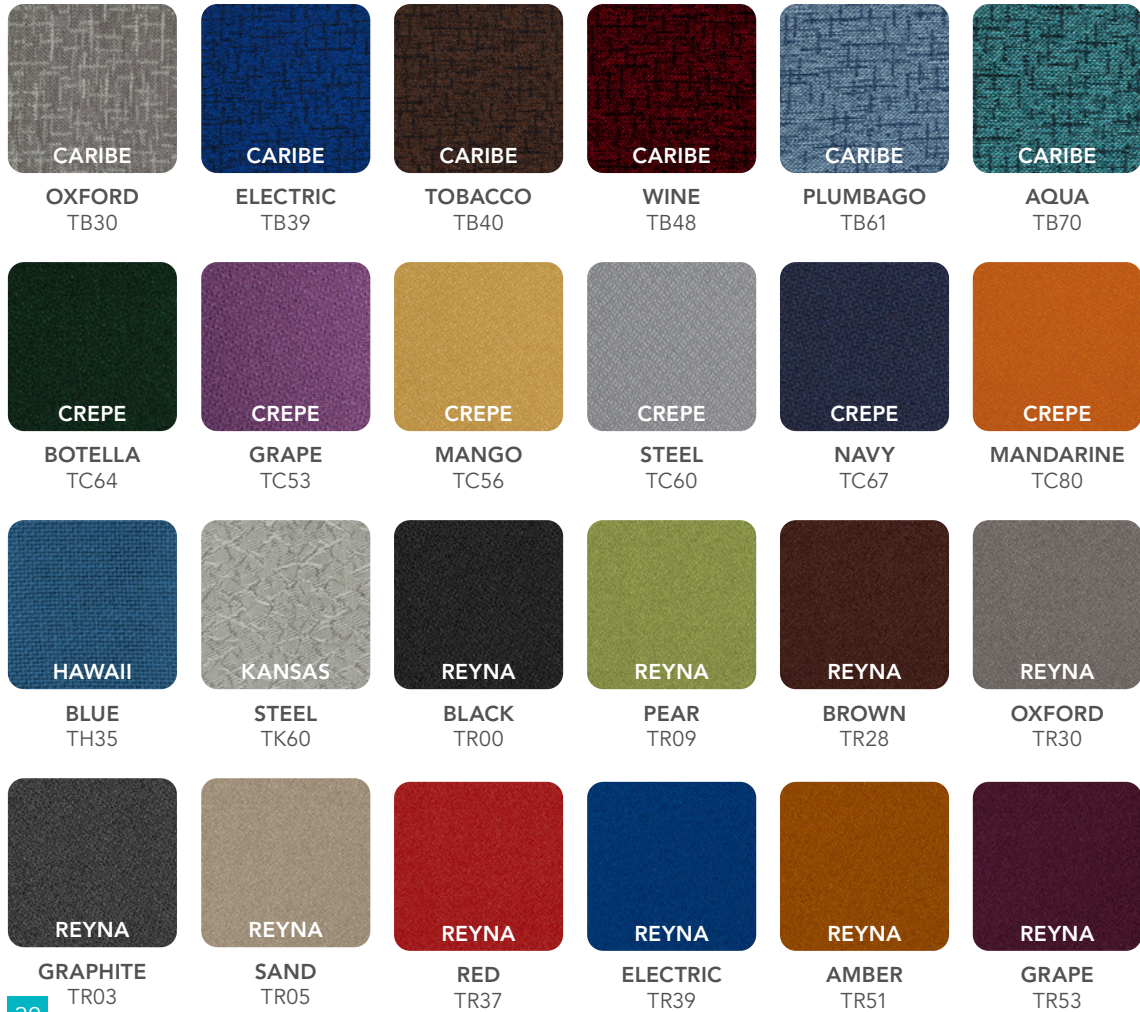

Furniture color may vary from images.

FABRIC DIRECTION
*See page 44 for Fabric Direction
Application Guidelines.



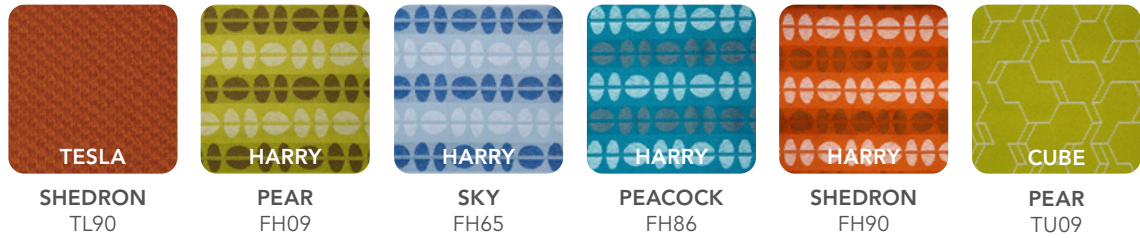

FABRIC GRADE C



FABRIC GRADE E

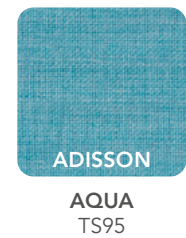

FABRIC DIRECTION
 *See page 44 for Fabric Direction
 Application Guidelines.



Furniture color may vary from images.

VINYL CATEGORY A

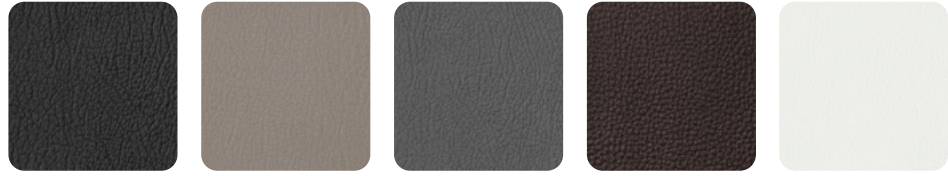

BLACK
TP00

BEIGE
TP02

GRAY
TP06

COFFEE
TP28

IVORY
TP81

VINYL CATEGORY B



DENALI
SAND
TP05

WALLABY
OFF WHITE
TP11

AVANTI
CHOCOLATE
TP23

RED
TP37

DENALI
E. SADDLE
TP55

DENALI
SADDLE BROWN
TP59

AQUA
TP70

ROYAL BLUE
TP76

WALLABY
RED
TP88

FABRIC DIRECTION
*See page 44 for Fabric Direction
Application Guidelines.



Furniture color may vary from images.

GUIDELINES

Fabrics that are **patterned, textured, or have sheen** can have a **distinctly different appearance if applied in different directions on chairs or panels**. Because of these differences, as well as width limits to how some fabrics can be applied to Gebesa products*, it is important to understand fabric applications.

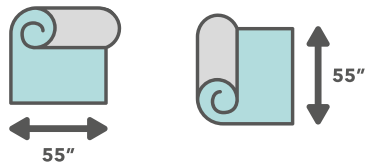

Fabrics **cannot be applied warp horizontal/railroaded** on panels with a **height greater than 48 inches** because panel height is greater than fabric width.

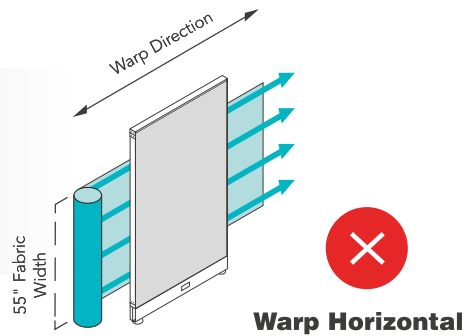

Fabrics **cannot be applied warp vertical** on panels with a **width greater than 48 inches** because panel width is greater than fabric width.

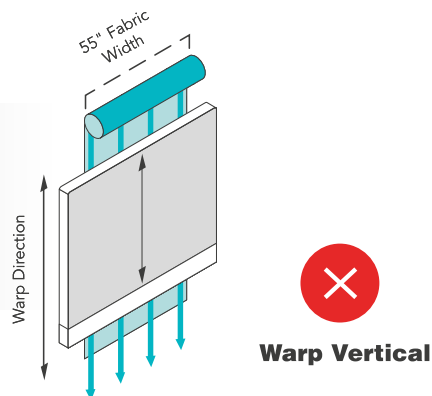

Gebesa is not responsible for charges associated with replacement or reupholstering of products due to incorrect fabric specifications.

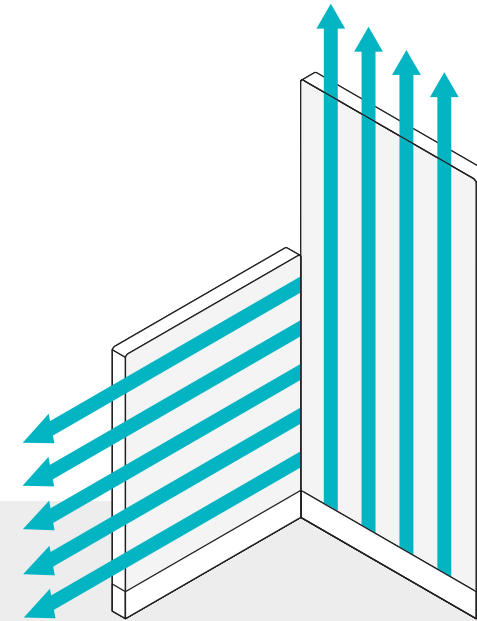

The combination of tall panels (height of 55 inches or more with warp vertical/off the roll) with short panels (height of 45 inches or less with warp horizontal) results in fabric patterns running in opposite directions.

The following options are available:

- Use solid or non-directional fabrics. (Various Gebesa fabrics are noted as "non-directional.")
- Specify warp vertical/off the roll application for fabrics that are standard warp horizontal.

If you require warp vertical and it is not standard for your fabric choice, you must specify the warp vertical option on each line of the order.

Gebesa
CREATING AMAZING SPACES