



Gebesa | CREATING AMAZING SPACES

START

4

Start

14

Typicals

15

Accessories

16

Quick Ship

20

Finishes



# START \_

Start allows you to maximize your space and your budget, offering the best combination of design, quality and price. Thanks to minimal components, Start is easy to install. It is also easy to expand, allowing for a large number of combinations to meet any space-planning need with customized configurations and high aesthetic value.

Optimize and save space with the strategic positioning of surfaces and bases as you elevate the functionality of each work area with accessories to enhance your work experience.

# SINGLE RUN

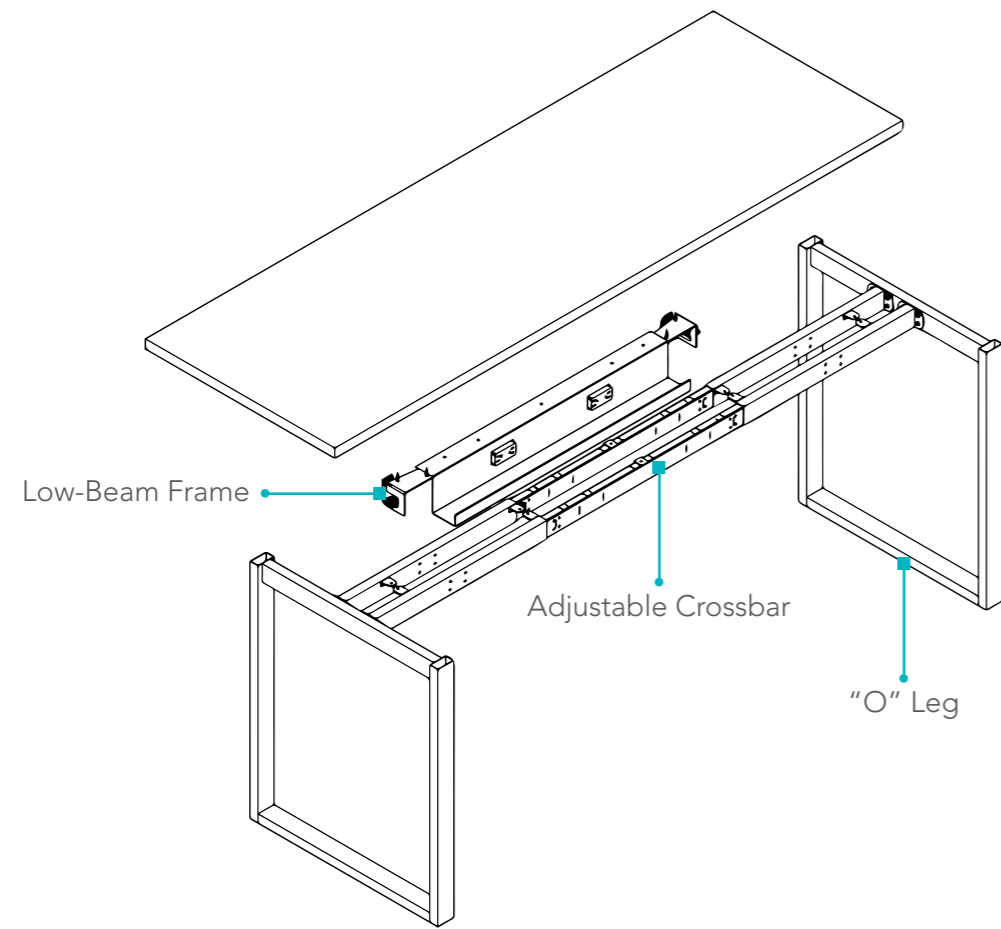

Optimize space in linear configuration with a single run system that offers hidden electrical access for voice and data.



# DOUBLE RUN

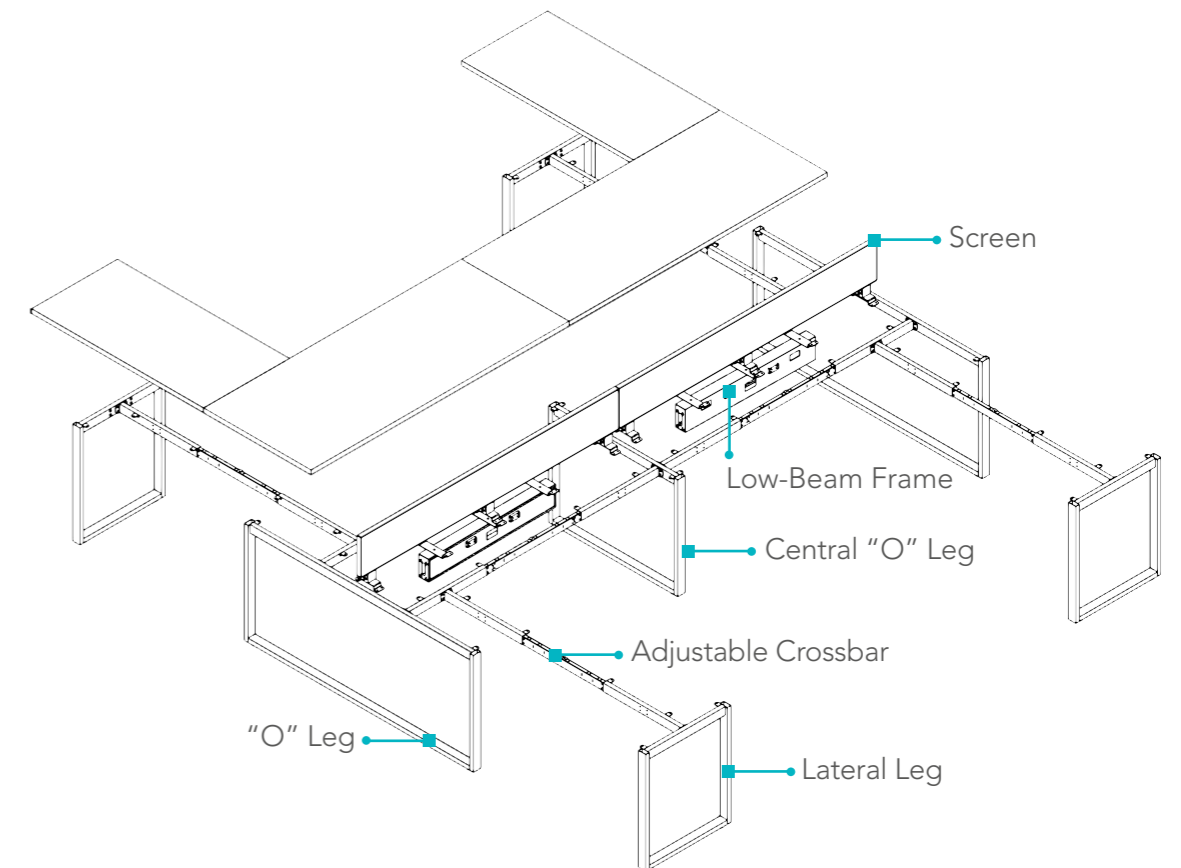

Start is perfect for the optimization and expansion of space and resources in offices with large work teams. With benching and double run systems, each workstation can adapt to technology demands with electrical access to voice and data in both directions.

# THE KEY TO ADAPTABILITY

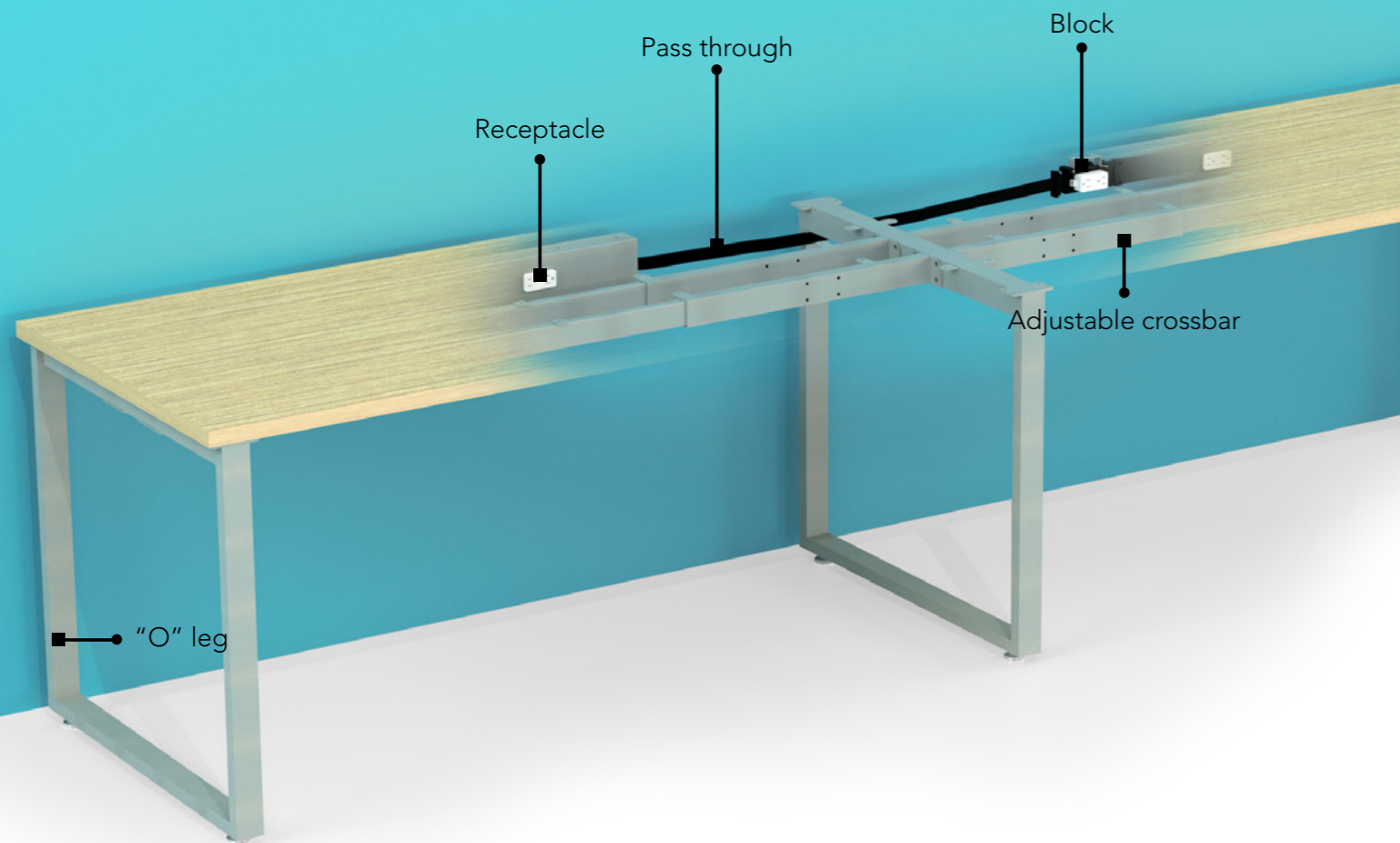

Thanks to the flexibility of Start, adapting to change is easier than ever.

Optimize responsiveness to changes in configurations. Go from a single run to a double run system to accommodate increases in work staff and the overall growth of your organization.

Adapt basic workstations to benching with a quick change of covers and repositioning of the adjustable crossbar. Add bases to increase the number of stations.



## BASE

Adapt your work area's dimensions and design with Start's various base options, including central, "O" and side legs, along with adjustable crossbar, ducts and gutters. For metal body colors, choose among black, white, textured aluminum and RM Gray.

## ADJUSTABLE CROSSBAR

**Base finishes:**  
Black, White, RM Gray,  
Textured Aluminum

**Height (with top):**  
30"

**Adjustable crossbar:**  
For configurations from 48°  
to 72°

**Warranty:**  
10 years

**Electrification:**  
Optional

**Work surface widths:**  
48", 60", 66" and 72"

**Work surface depths:**  
24" and 30"

## ADJUSTABLE CROSSBAR

The adjustable crossbar lends stability to your furniture and reinforces the cover. It can expand to the size of the stringer, thanks to a design that opens and closes as needed.

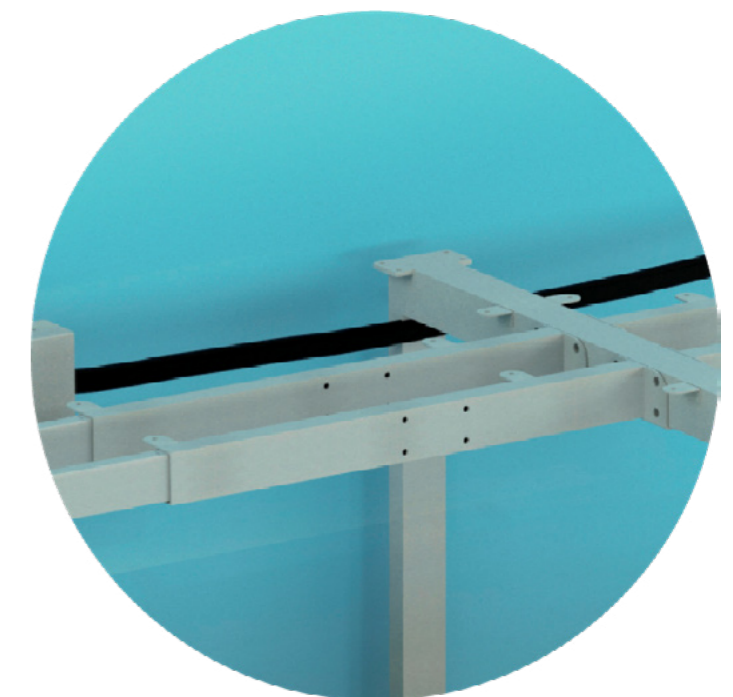



## Beam Power & Data Distribution System

Beam's flexible design keeps cables hidden, providing electrification in each station through knockouts, harnesses and ducts under covers. Choose the Beam benching version for double run configurations with users on both sides or single run for individual stations.

# TYPICALS

2-USER



Option A



Option B



Option I

3-USER



Option C

4-USER



Option D



Option E

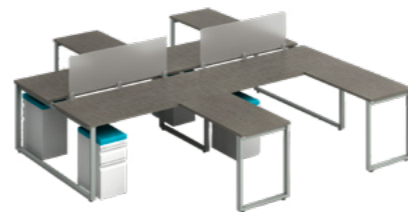

Option F

6-USER

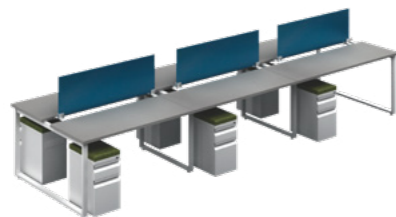

Option G



Option H

## SCREENS AND CLAMPS



Fabrics



Acrylic

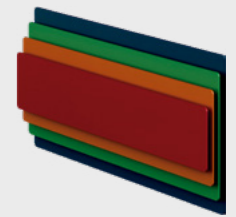

MDF

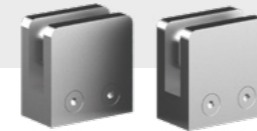

Clamps



Screen Holder

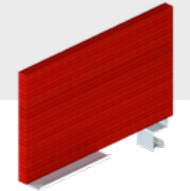

Freestanding Screen  
(Metal or tackable)

## ORGANIZATION / MOUNTING



Monitor Arms



Vertebrae



Power Data



Soft Cable  
Management

## STORAGE



Metal Pedestals  
12" and 15"

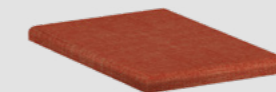

Pedestal Cushion



Metal Pedestals with Laminate Top





# QUICK SHIP

## BASES

### DESCRIPTION

### CODE

### DIMENSIONS

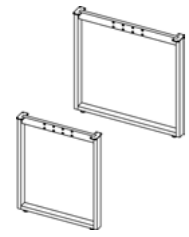

#### LATERAL LEGS

- Colors: Black, Textured Aluminum
- Single run
- For Start work surface only

**GAR826060**

24" x 28"

**GAR826075**

30" x 28"



#### "O" LEG

- Colors: Black, Textured Aluminum
- Double run
- For 24" and 30" work surfaces
- For Start work surface only

**GAR825130**

52" x 28"

**GAR825160**

63" x 28"



#### CENTRAL LEG DOUBLE RUN

- Colors: Black, Textured Aluminum
- Single and double run

**GAR827090**

36 x 28"



#### ADJUSTABLE CROSSBAR

- Colors: Black, Textured Aluminum
- Single run
- For Start work surface only

**GAR867010**

Adjustable from 42" to 72"

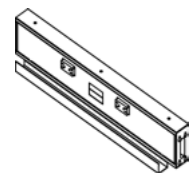

#### BENCHING BEAM

- Colors: Black, Textured Aluminum

**GAH839090**

34" x 2.75" x 6"

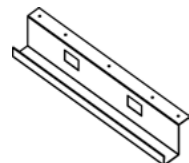

#### BENCHING BEAM SINGLE RUN

- Colors: Black, Textured Aluminum

**GAR841075**

29" x 4" x 5"

## SURFACES

### DESCRIPTION

### CODE

### DIMENSIONS

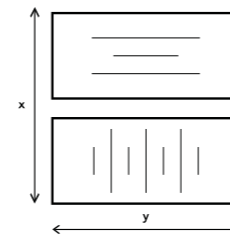

Horizontal (H) Vertical (V)  
Width (y) x Depth (x)

#### STRAIGHT WORKSURFACE

- Worksurfaces over 48" include a stiffener
- Worksurface thickness: 28 mm., particle board work surfaces, edge banding 2 mm thickness.

**GAR9314824**  
**GAR9316024**  
**GAR9316530**  
**GAR9317224**

47" x 24" x 1"  
59" x 24" x 1"  
64" x 24" x 1"  
71" x 24" x 1"

## ACCESSORIES

### DESCRIPTION

### CODE

### DIMENSIONS

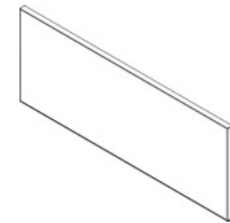

#### FABRIC SCREENS

- 27 mm. thickness
- No clamps included

**GAH853050**  
**GAH853090**  
**GAH853120**  
**GAH853150**  
**GAH853180**

18" x 12"  
34" x 12"  
46" x 12"  
58" x 12"  
70" x 12"

**GAH854050**  
**GAH854090**  
**GAH854120**  
**GAH854150**  
**GAH854180**

18" x 12"  
34" x 12"  
46" x 12"  
58" x 12"  
70" x 12"

**GAH856090**  
**GAH856120**  
**GAH856150**  
**GAH856180**

34" x 12"  
46" x 12"  
58" x 12"  
70" x 12"

**GAH857090**  
**GAH857120**  
**GAH857150**  
**GAH857180**

34" x 12"  
46" x 12"  
58" x 12"  
70" x 12"

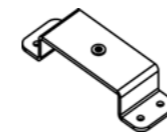

#### SCREEN BRACKET

- Colors: Black, Textured Aluminum

**GAR849160**

6" x 2"

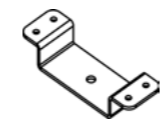

#### RACEWAY BRACKET

- Colors: Black, Textured Aluminum

**GAR840160**

6" x 2"

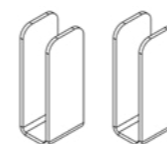

#### CLAMPS

(for fabric screens)

**GAH-BTD**

# QUICK SHIP

## DESCRIPTION

## CODE

## DIMENSIONS



- METAL BF PEDESTAL (MOBILE)**
- Colors: White, Black, Textured Aluminum
  - 1 drawer
  - 1 file cabinet

**GAH306030**

15 x 18 x 22"

**GAH306040**

12 x 18 x 22"



- DEAN**
- 1 power
  - 1 USB dual

**BE04315-1-1A-A-120**

120" cord

**BE04315-1-1A-A-72**

72" cord



- MIKI**
- White/Black color
  - 1 power
  - 1 USB A + 1 USB C

**BE010017TR-1-1AC-EM-108**

108" cord



- MIKI**
- White/Black color
  - 2 power
  - 1 USB A + 1 USB C

**BE010017TR-2-1AC-EM-108**

108" cord



**REACH DUAL MONITOR ARM**

**GAC998MD**



**REACH SINGLE MONITOR ARM**

**GAC998MS**

## FINISHES WORKSURFACES



**WENGUE**  
BP23



**BAY SAND**  
BP38



**STORM GRAY**  
BP43

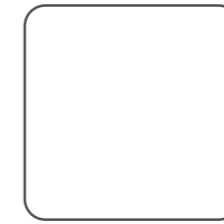

**WHITE**  
BP11

## PEDESTALS

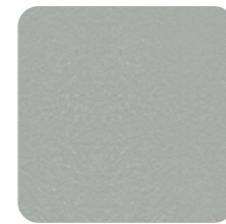

**TEXT. ALUMINUM**  
PT01



**BLACK**  
PL00

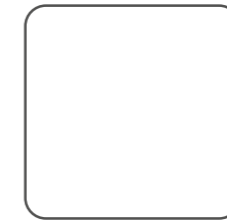

**WHITE**  
PL11

## STRUCTURE



**TEXT. ALUMINUM**  
PT01



**BLACK**  
PL00

# FINISHES



	WOOD VENEER	LOW PRESSURE	HIGH PRESSURE	POWDER COATING	LIQUID COATING	FABRICS B, C, E	ACRYLIC
Worksurfaces	•	•	•				
Structure				•			
MDF Screens			•		•		
Fabric Screens						•	
Fabric Screen clamps				•			
Acrylic Screens							•
Cushions						•	

Note: Laminated MDF Screens are only available in whiteboard laminate.

# LAMINATES

## WOOD VENEER



## LOW PRESSURE LAMINATES



Furniture color may vary from images.

## HIGH PRESSURE LAMINATES



# POWDER COATING

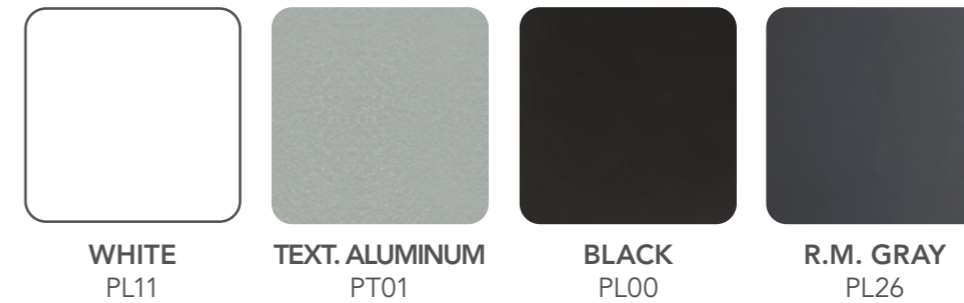

# LIQUID COATING

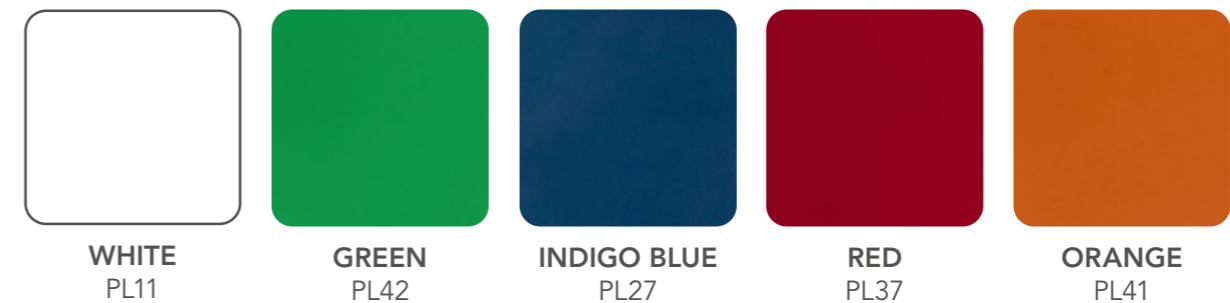

# FABRICS

Furniture color may vary from images.

## FABRIC GRADE A



## FABRIC GRADE B

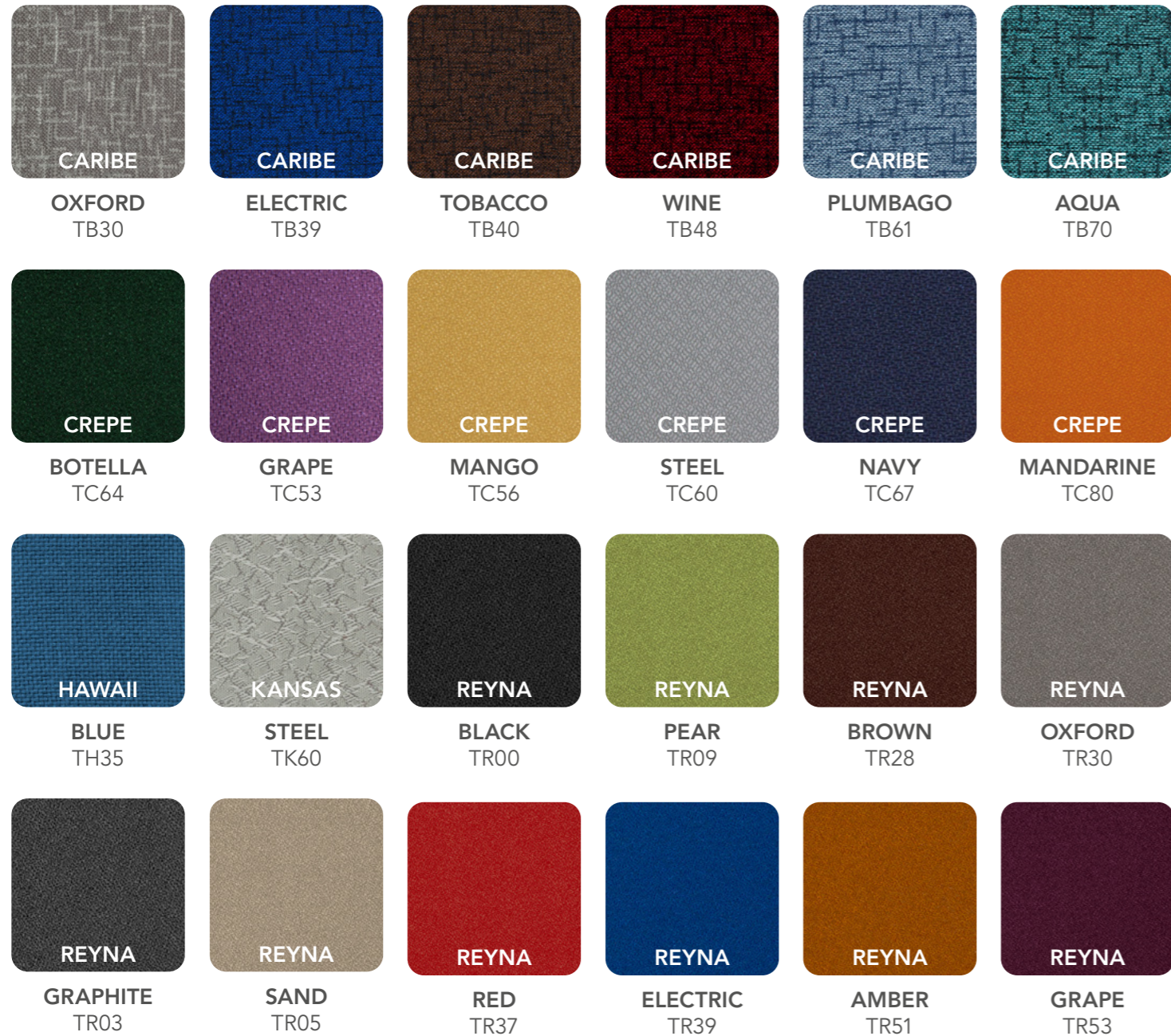



FABRIC GRADE C



FABRIC GRADE E

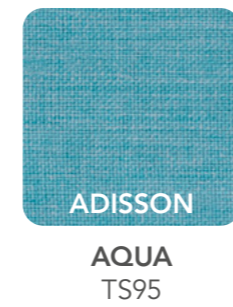

Furniture color may vary from images.

**Gebesa**  
CREATING AMAZING SPACES