



**Gebesa** | CREATING AMAZING SPACES

**SYNERGY**

4

STRUCTURE

12

GALLERY  
PANELS

16

WORKSURFACES

18

PEDESTALS

20

FILING AND  
STORAGE

22

MOUNTING  
TILES

24

COLLABORATIVE  
TABLES

26

ACCESSORIES

30

POWER AND  
DATA

32

DIMENSIONS

40

FINISHES

50

GUIDELINES



*Furniture color may vary from renderings.*

# SYNERGY

The basis of Synergy is upholstered or laminated monolithic panels, which create functional spaces with a simple, acoustic solution. Easy to assemble and with wire management capabilities, this collection inspires productivity and efficiency.

Synergy provides quick response to the specific needs of dynamic workplaces without compromising functionality and image—along with a wide variety of accessories to equip and customize your workstations.

# STRUCTURE

SYNERGY

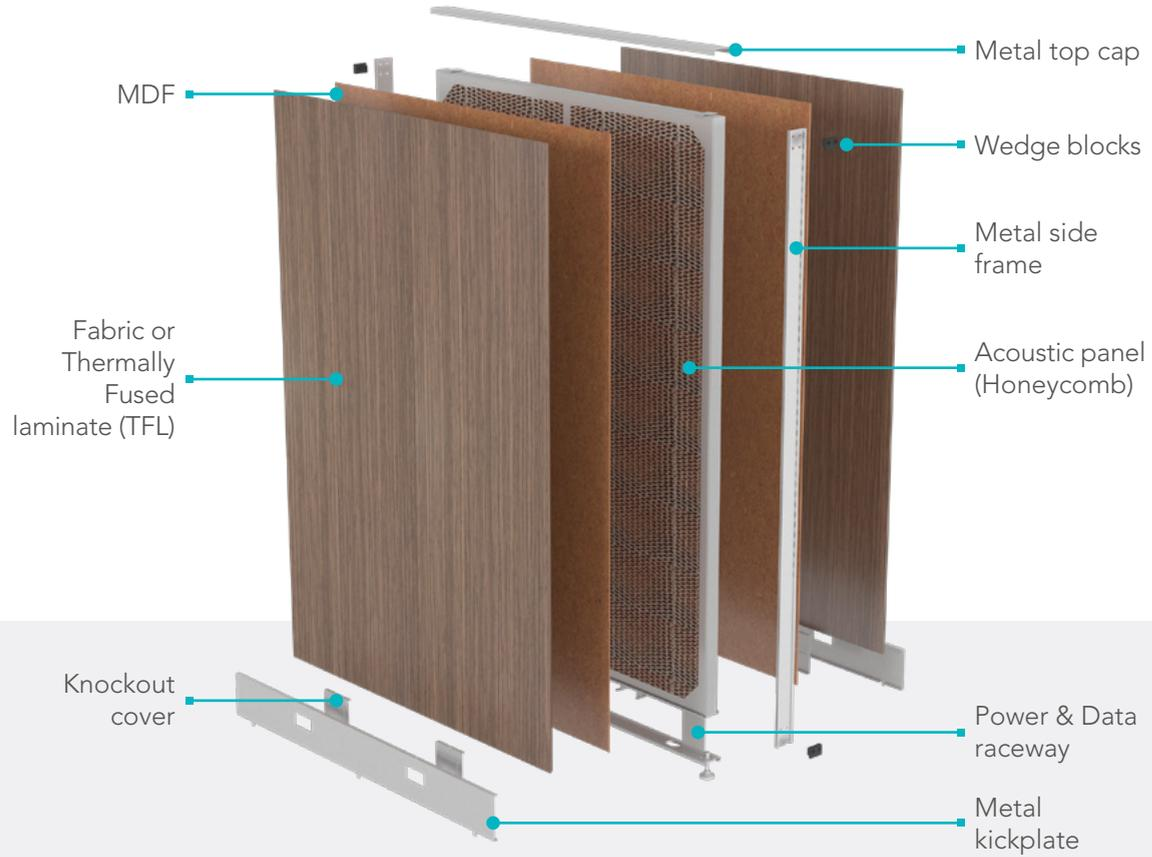



Furniture color may vary from renderings.



# Panels

The design of the Synergy panels creates a uniform and elegant finish. It has a thickness of 2". Choose fabric or low-pressure finishes.

Adapt the workstations according to your needs with the different measures available, ranging from 35" to 85" in height and 18" to 60" in width.



Furniture color may vary from renderings.

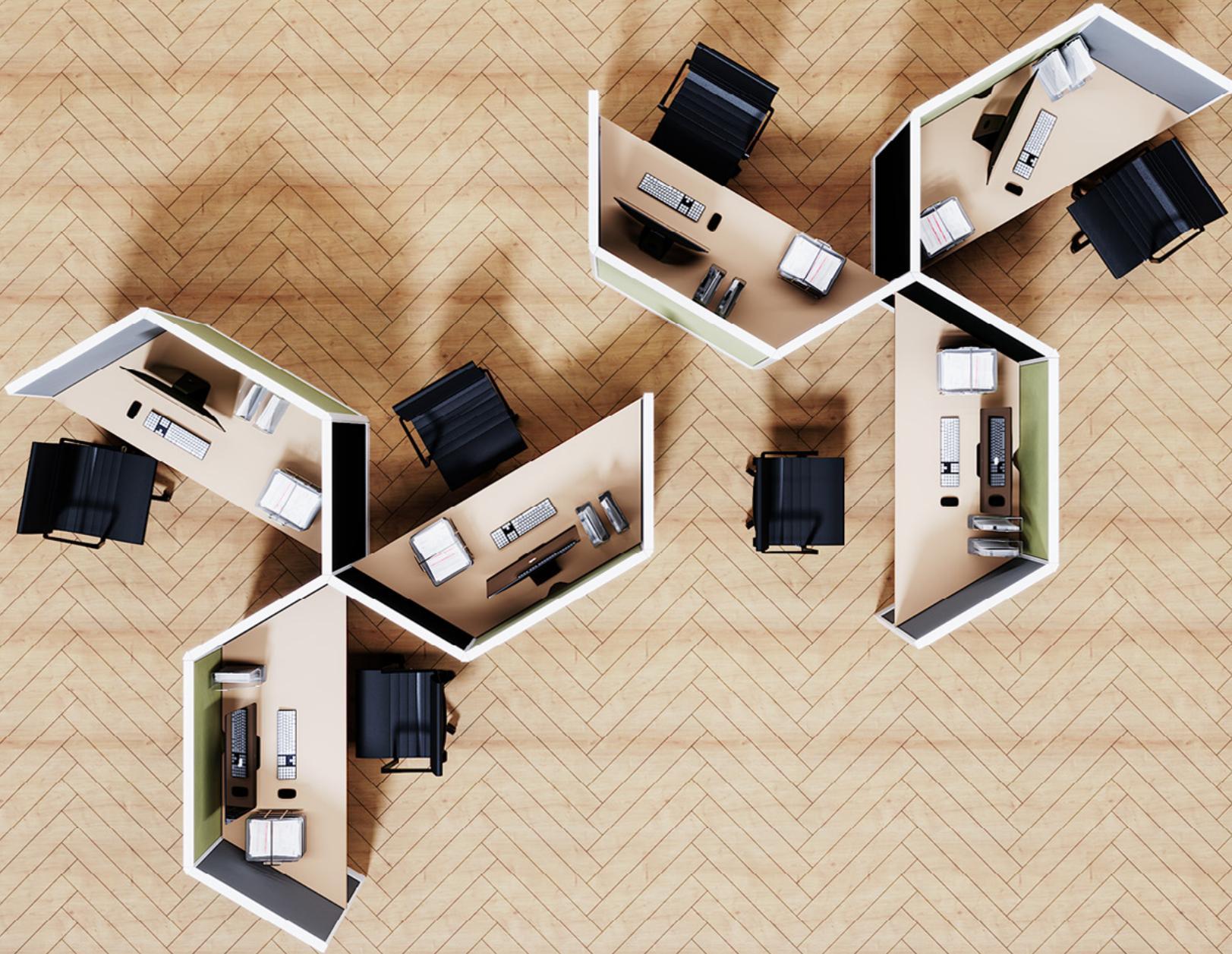

## Make it your own

Optimize the functions of your workstation based on modular systems with panel connectors. Adapt the length to the height of your panel, which measures 2x2". Install between panels whenever your design requires a change of direction.

The metal finishing caps of the Synergy line, designed to be placed on the final panel of your configuration, guarantee an optimal aesthetic by closing the metal structure that allows the joints to use wedges, leaving its interior hidden.

# A world of possibilities!

Thanks to the wedge blocks, keep each panel attached and select how the panels coexist, making the most of the spaces.

Choose the finishes and dimensions of your modular system, make the most of its power source at the bottom, and create a space fully adapted to the needs of your office.

Wedge Blocks

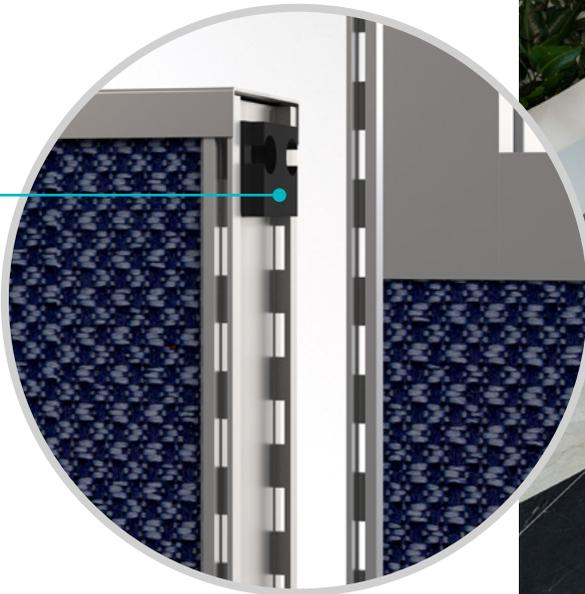

*Furniture color may vary from renderings.*



Furniture color may vary from renderings.

## A NEW LEVEL OF PERSONALIZATION OF SPACES!

Gallery Panels are an affordable, elegant, and practical way to incorporate separation and privacy into your panel system configuration. Customize your environment with a wide variety of low-pressure finishes.

Our Gallery Panels can be attached to create divisions, through junctions with the panels, or at the end of a configuration - redefines the boundaries of a workspace.

## CONFIGURATIONS



"L" Configuration



"T" Configuration



"Y" Configuration



"X" Configuration



Panel



Gallery Panel



Furniture color may vary from renderings.

# WORKSURFACES

SYNERGY

Furniture color may vary from renderings.



Straight



Transition - Curved



Transition - Straight



Corner - Curved



Corner - Straight



Bullet



Hatchet



Peninsula



"P" Top



Irregular



End



Boomerang



1/4 Round



Half-Round



Transaction Counter



# PEDESTALS

SYNERGY



File/File  
Metallic Pedestal



Box/Box/File  
Metallic Pedestal



LPL, HPL, Veneer  
Pedestal

## HANDLES (For LPL, HPL, or VENEER pedestal fronts)

### Standard Handles



Platinum

Black

### Additional Handle Options



Kenza

Spazio

Senior

Millenium



Furniture color may vary from renderings.

# FILING AND STORAGE

SYNERGY



## LATERAL FILES



Global 2-drawer metal lateral file



Metal combo file



Laminate and Veneer Fronts



Metal Structure

## OVERHEAD



Open Overhead



Overhead with Flipper Door

The overheads can be:

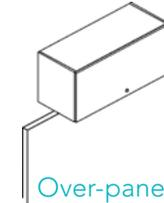

Over-panel

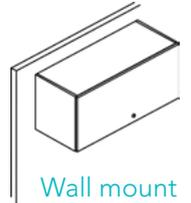

Wall mount

# MOUNTING TILES

SYNERGY



## TACKABLE MOUNTING TILE

Solve task organization needs in your modular system. Install our puncturable panel and optimize space by placing it directly on the screen.



## WHITEBOARD MOUNTING TILE

Install our paint patch on the screens of your Synergy modular system and exchange ideas between collaborators and write down notes, issues or info.



## MOUNTING TILE

Create an optimal base for other accessories to be fastened such as a vase holder or pen. Our panel achieves the right conditions for all elements to have their place.



# COLLAB. TABLES

SYNERGY

Furniture color may vary from renderings.



*Bullet Table*



*Boat Table*



*Rectangular Table*



*Bulb Table*

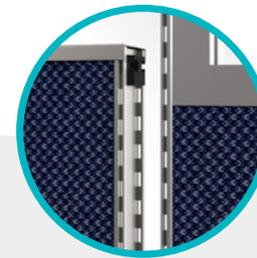

Can be used with Panel Systems

Collaborative Tables bring elegance to any space. Position your way from boardrooms and offices to training and break rooms.

Mix and match with Synergy Panels to create the ultimate ergonomic and collaborative work environment.



# ACCESSORIES: ACRYLIC DOORS

SYNERGY

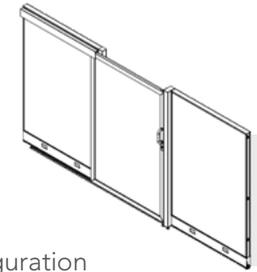

Straight Configuration

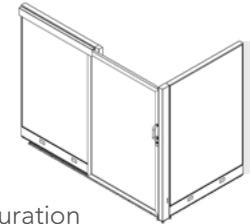

"L" Configuration

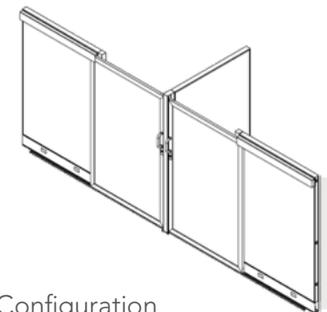

"T" Configuration

# ACCESSORIES

SYNERGY

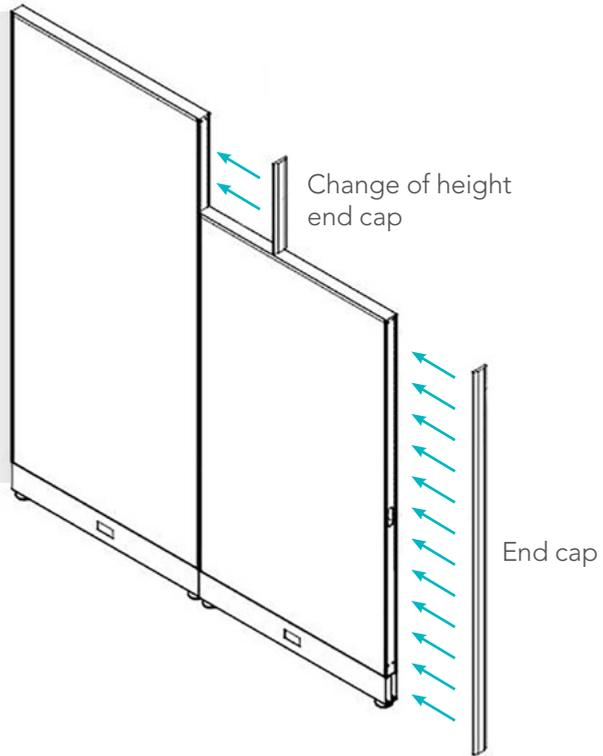

- 1.- POWER POLE FOR CONNECTOR
- 2.- END CAPS



# POWER AND DATA

SYNERGY



- **8-Trac:** Height A / "Y" Dimension .875 / "Z" Dimension 2.14
- **Phase 3:** Height C / "Y" Dimension 1.125 / "Z" Dimension 2.64

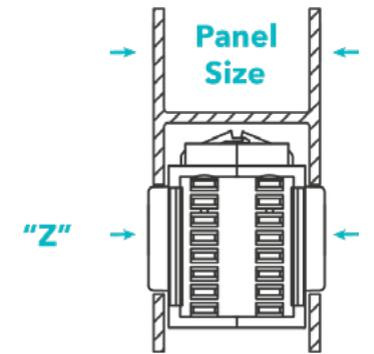
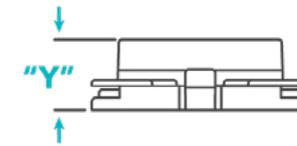

# DIMENSIONS

## SYNERGY

Note: Depth and width shown in nominal dimensions.

### MONOLITHIC PANELS (Height 35" (90 cm) / 2" depth)

W: 18" (45 cm) | 24" (60 cm) | 30" (75 cm) | 36" (90 cm) | 42" (105 cm) | 48" (120 cm) | 60" (150 cm)

### MONOLITHIC PANELS (Height 45" (115 cm) / 2" depth)

W: 18" (45 cm) | 24" (60 cm) | 30" (75 cm) | 36" (90 cm) | 42" (105 cm) | 48" (120 cm) | 60" (150 cm)

### MONOLITHIC PANELS (Height 55" (140 cm) / 2" depth)

W: 18" (45 cm) | 24" (60 cm) | 30" (75 cm) | 36" (90 cm) | 42" (105 cm) | 48" (120 cm) | 60" (150 cm)

### MONOLITHIC PANELS (Height 65" (165 cm) / 2" depth)

W: 18" (45 cm) | 24" (60 cm) | 30" (75 cm) | 36" (90 cm) | 42" (105 cm) | 48" (120 cm)

### MONOLITHIC PANELS (Height 75" (190 cm) / 2" depth)

W: 18" (45 cm) | 24" (60 cm) | 30" (75 cm) | 36" (90 cm) | 42" (105 cm) | 48" (120 cm)

### MONOLITHIC PANELS (Height 85" (215 cm) / 2" depth)

W: 18" (45 cm) | 24" (60 cm) | 30" (75 cm) | 36" (90 cm) | 42" (105 cm) | 48" (120 cm)

### KNOCKOUTS PER PANEL

18" (1) | 24" (1) | 30" (2) | 36" (2) | 42" (2) | 48" (2) | 60" (2)

### PANEL CONNECTOR (2" x 2")

35" (90 cm) | 45" (115 cm) | 55" (140 cm) | 65" (165 cm) | 75" (190 cm) | 85" (215 cm)

### POWER POLE FOR CONNECTOR

10" (25 cm) | 30" (75 cm) | 50" (125 cm) | 70" (175 cm) | 90" (225 cm)

### END CAPS

35" (90 cm) | 45" (115 cm) | 55" (140 cm) | 65" (165 cm) | 75" (190 cm) | 85" (215 cm)

### CHANGE OF THE END CAP

10" (25 cm) | 20" (50 cm) | 30" (75 cm) | 40" (100 cm) | 50" (125 cm)

### GALLERY PANELS - "L", "T" CONFIGURATION - 36"

24 x 36" | 30 x 36" | 36 x 36" | 42 x 36" | 48 x 36" | 60 x 36" | 72 x 36"

### GALLERY PANELS - "L", "T" CONFIGURATION - 45"

24 x 45" | 30 x 45" | 36 x 45" | 42 x 45" | 48 x 45" | 60 x 45" | 72 x 45"

### GALLERY PANELS - "L", "T" CONFIGURATION - 55"

24 x 55" | 30 x 55" | 36 x 55" | 42 x 55"

# DIMENSIONS

## SYNERGY

Note: Depth and width shown in nominal dimensions.

### GALLERY PANEL - "Y", "X" CONFIGURATION - 36"

48" x 36" | 60" x 36" | 72" x 36" | 85" x 36"

### GALLERY PANEL - "Y", "X" CONFIGURATION - 45"

48" x 45" | 60" x 45" | 72" x 45" | 85" x 45"

### STRAIGHT WORKSURFACES (Depths: 24" (60 cm) / 30" (75 cm))

18" (45 cm) | 24" (60 cm) | 30" (75 cm) | 36" (90 cm) | 42" (105 cm) | 48" (120 cm) | 60" (150 cm) | 72" (180 cm)

### TRANSITION - CURVED (Depth 30" (75 cm) / Connection (Z) 24" (60 cm))

W: 30" (75 cm) | 36" (90 cm) | 42" (105 cm) | 48" (120 cm) | 60" (150 cm) | 72" (180 cm)

### TRANSITION - STRAIGHT (Depth 30" (75 cm) / Connection (Z) 24" (60 cm))

W: 30" (75 cm) | 36" (90 cm) | 42" (105 cm) | 48" (120 cm) | 60" (150 cm) | 72" (180 cm)

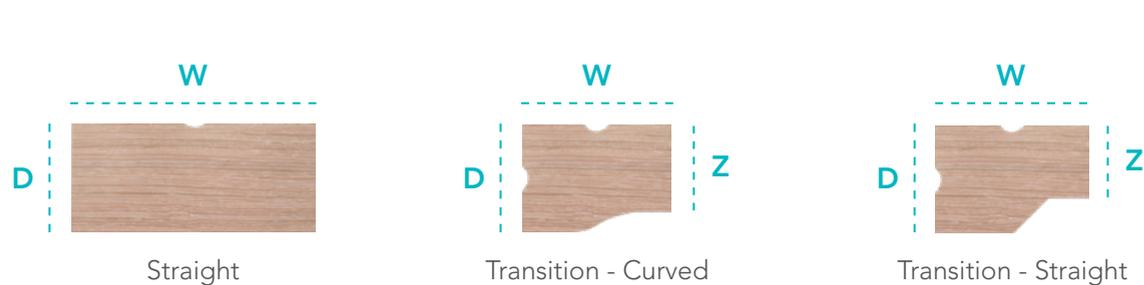

### CORNER (CURVED AND STRAIGHT) WORKSURFACE (D x W x Z)

36" (90 cm) x 36" (90 cm) x 24" (60 cm) | 36" (90 cm) x 42" (105 cm) x 24" (60 cm)  
48" (120 cm) x 36" (90 cm) x 24" (60 cm) | 42" (105 cm) x 42" (105 cm) x 24" (60 cm)  
42" (105 cm) x 42" (105 cm) x 30" (75 cm) | 48" (120 cm) x 42" (105 cm) x 24" (60 cm)  
48" (120 cm) x 42" (105 cm) x 30" (75 cm) | 60" (150 cm) x 36" (90 cm) x 24" (60 cm)  
48" (120 cm) x 48" (120 cm) x 24" (60 cm) | 48" (120 cm) x 48" (120 cm) x 30" (75 cm)  
60" (150 cm) x 42" (105 cm) x 24" (60 cm) | 60" (150 cm) x 42" (105 cm) x 30" (75 cm)  
60" (150 cm) x 48" (120 cm) x 24" (60 cm) | 60" (150 cm) x 48" (120 cm) x 30" (75 cm)

### BULLET WORKSURFACE (D x W)

24" (60 cm) x 60" (150 cm) | 24" (60 cm) x 65" (165 cm) | 24" (60 cm) x 72" (180 cm)  
30" (75 cm) x 60" (150 cm) | 30" (75 cm) x 65" (165 cm) | 30" (75 cm) x 72" (180 cm)

### HATCHET AND PENINSULA WORKSURFACES (D x W x Z)

36" (90 cm) x 72" (180 cm) x 24" (60 cm) | 36" (90 cm) x 72" (180 cm) x 30" (75 cm)

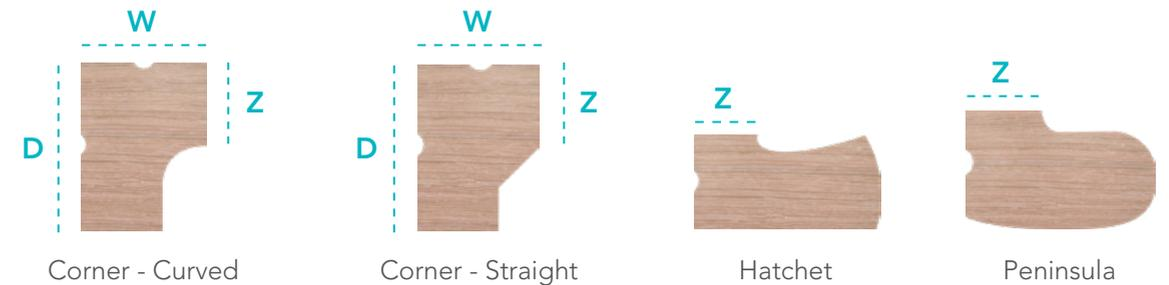

# DIMENSIONS

## SYNERGY

Note: Depth and width shown in nominal dimensions.

### "P" TOP WORKSURFACE (D x W x Z)

36" (90 cm) x 72" (180 cm) x 30" (75 cm)

### IRREGULAR WORKSURFACE (D x W x Z)

30" (75 cm) x 60" (150 cm) x 24" (60 cm) | 30" (75 cm) x 72" (180 cm) x 24" (60 cm)

30" (75 cm) x 72" (180 cm) x 30" (75 cm)

### END WORKSURFACE (Depth 24" (60 cm))

24" (60 cm) | 30" (75 cm) | 36" (90 cm) | 42" (105 cm) | 48" (120 cm)

### END WORKSURFACE (Depth 30" (75 cm))

24" (60 cm) | 30" (75 cm) | 36" (90 cm) | 42" (105 cm) | 48" (120 cm)

### 1/4 ROUND WORKSURFACE

24" (60 cm) x 24" (60 cm) | 30" (75 cm) x 30" (75 cm)

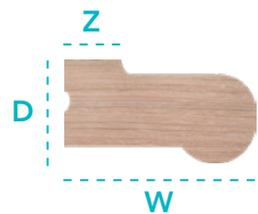

"P" Top

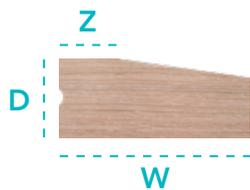

Irregular

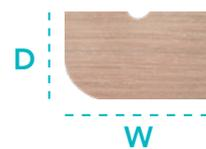

End

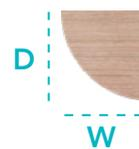

1/4 Round

### BOOMERANG WORKSURFACE (D x W x Z)

24" (60 cm) x 42" (105 cm) x 24" (60 cm) | 24" (60 cm) x 42" (105 cm) x 30" (75 cm)

### HALF-ROUND WORKSURFACE (D x W)

24" (60 cm) x 50" (125 cm) | 30" (75 cm) x 62" (155 cm)

### TRANSACTION COUNTER - STRAIGHT WORKSURFACE (D x W)

14" (35 cm) x 24" (60 cm) | 14" (35 cm) x 30" (75 cm) | 14" (35 cm) x 36" (90 cm)

14" (35 cm) x 42" (105 cm) | 14" (35 cm) x 48" (120 cm) | 14" (35 cm) x 60" (150 cm)

### TRANSACTION COUNTER - CORNER WORKSURFACE (D x W x Z)

43.5" (110 cm) x 43.5" (110 cm) x 14" (35 cm)

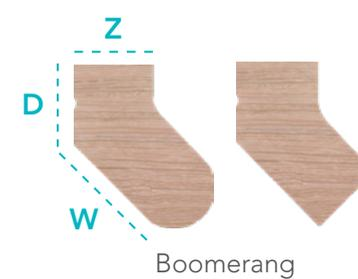

Boomerang



Half-Round

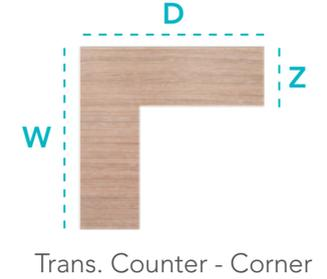

Trans. Counter - Corner

### PANELS FOR BOOKCASE

15" x 16" | 15" x 26" | 15" x 35" | 15" x 41"

### MOUNTING TILES

- Tackable: 24" x 12" | 30" x 12" | 36" x 12" | 42" x 12" | 48" x 12"
- Mounting Tile: 24" x 10" | 30" x 10" | 36" x 10" | 42" x 10" | 48" x 10"

### FILING AND STORAGE

- Pedestals: 16" x 23" x 29"
- Lateral File: 35" x 19" x 28"
- Combo file: 32" x 23" x 28"
- Storage Cabinets: 24 x 24 x 45" | 24 x 24 x 55" | 24 x 24 x 65" | 24 x 24 x 72"
- Shelves: 18" x 14" x 6" | 24" x 14" x 6" | 30" x 14" x 6" | 35" x 14" x 6" | 41" x 14" x 6" | 47" x 14" x 6"
- Overheads: 24" x 15" x 16" | 30" x 15" x 16" | 35" x 15" x 16" | 41" x 15" x 16" | 47" x 15" x 16"

### COLLABORATIVE PENINSULA TOPS

59" x 47" | 71" x 47"

### MIXED PANELS (Height 45" (115 cm) / 2" depth)

W: 24" (60 cm) | 30" (75 cm) | 36" (90 cm) | 42" (105 cm) | 48" (120 cm) | 60" (150 cm)

### MIXED PANELS (Height 55" (140 cm) / 2" depth)

W: 24" (60 cm) | 30" (75 cm) | 36" (90 cm) | 42" (105 cm) | 48" (120 cm) | 60" (150 cm)

### MIXED PANELS (Height 65" (165 cm) / 2" depth)

W: 24" (60 cm) | 30" (75 cm) | 36" (90 cm) | 42" (105 cm) | 48" (120 cm) | 60" (150 cm)

### MIXED PANELS (Height 75" (190 cm) / 2" depth)

W: 24" (60 cm) | 30" (75 cm) | 36" (90 cm) | 42" (105 cm) | 48" (120 cm)

### MIXED PANELS (Height 85" (215 cm) / 2" depth)

W: 24" (60 cm) | 30" (75 cm) | 36" (90 cm) | 42" (105 cm) | 48" (120 cm)

### FROSTED ACRYLIC DOORS

- For Straight conf.: 65" | 75" | 85"
- For "L" conf.: 65" | 75" | 85"
- For "T" conf.: 75" | 85"

# FINISHES

SYNERGY



	WOOD VENEER	LOW PRESSURE	HIGH PRESSURE	WHITEBOARD	POWDER COATING	FABRIC A-E	ACRYLIC
Synergy Worksurfaces	•	•	•				
Synergy Panels		•				•	•
Synergy Structure					•		
Gallery Panels	•	•					
Metal Pedestals Structure					•		
Metal Pedestals Fronts	•	•	•		•		
Synergy Pedestals					•		
Shelves and Overheads	•	•	•		•		
Overhead - Flipper Door	•	•	•	•	•	•	
Cabinets Structure					•		
Cabinets Fronts	•	•			•		
Frosted Acrylic Doors							•
Acrylic Doors Frame					•		

# LAMINATES

## WOOD VENEER



WALNUT CN16    TAMARIND CN17    SILVER APRICOT CN19    WENGUE CN23    CHERRY CN29

## LOW PRESSURE LAMINATES



BLACK BP00    CHERRY BP04    ENGLISH OAK BP07    PEAR BP09    SILVER BP10    WHITE BP11



MAPLE BP12    TOAST WALNUT BP16    BORDEAUX BP18    PLATINUM BP20    WENGUE BP23    ANIGRE BP24



OXFORD BP30    SPANISH OAK BP34    BAY SAND BP38    STORM GRAY BP43    COSMOP. GRAY BP49    ARCTIC SKYLINE BP78

## HIGH PRESSURE LAMINATES

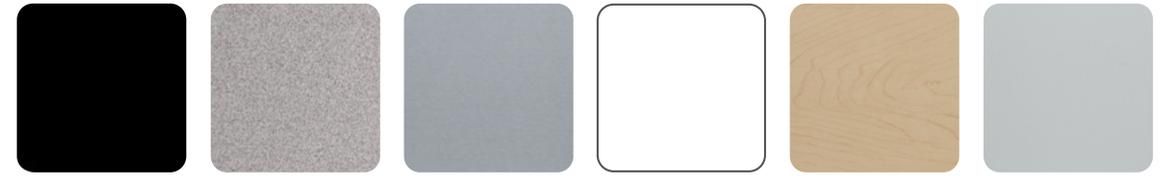

BLACK AP00    NEBULA AP08    SILVER AP10    WHITE AP11    MAPLE AP12    PLATINUM AP20



WENGUE AP23    SPANISH OAK AP34    MAHOGANY AP62    WHITEBOARD AP99

# POWDER COATING

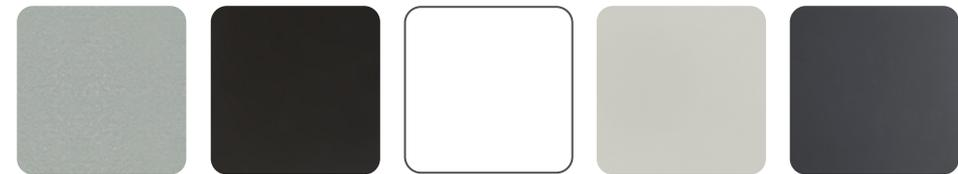

TEXT. ALUMINUM PT01    BLACK PL00    WHITE PL11    PLATINUM PL20    R.M. GRAY PL26

# FABRICS

## FABRIC GRADE A

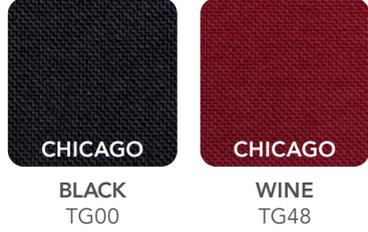

## FABRIC GRADE B

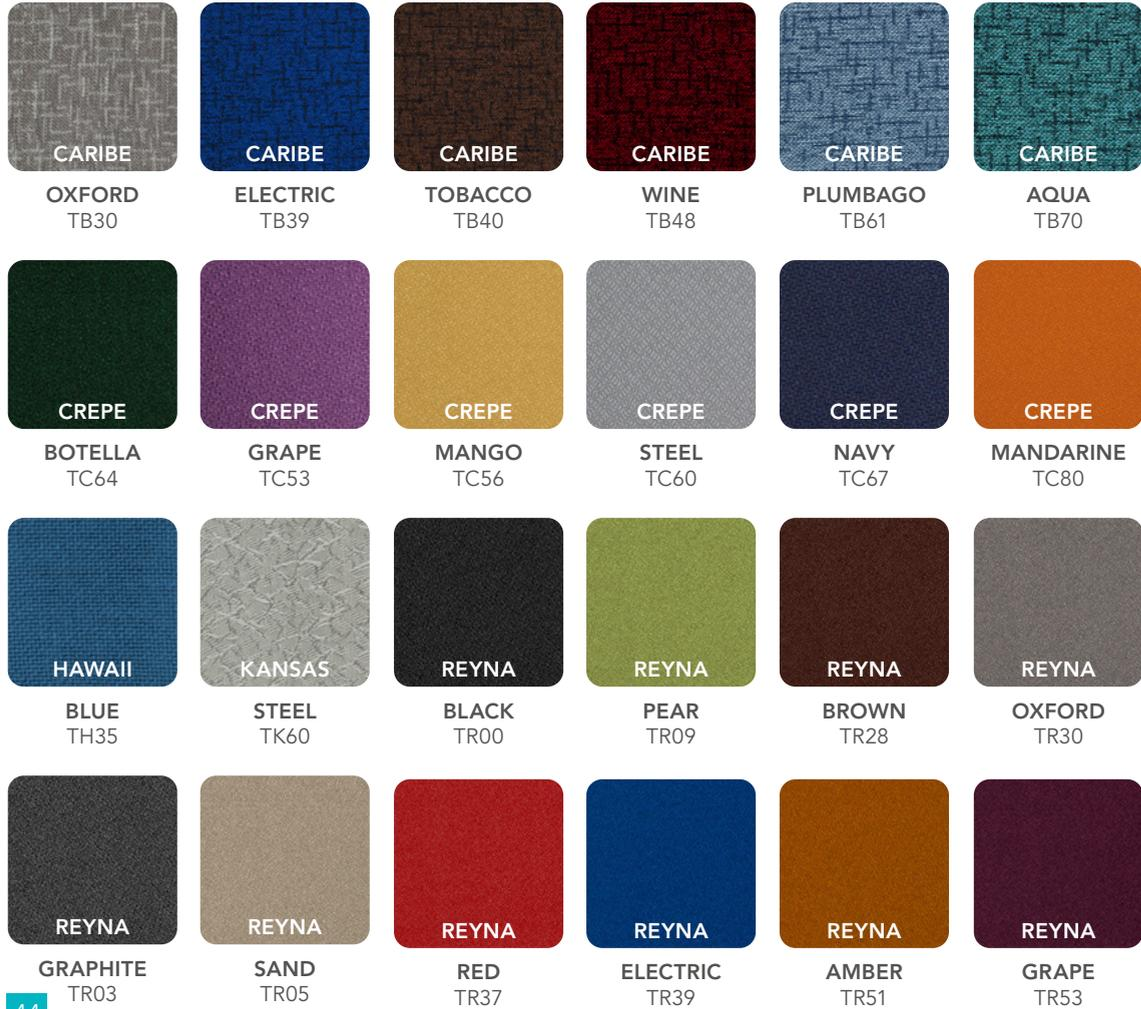

FABRIC DIRECTION  
\*See page 50 for Fabric Direction  
Application Guidelines.





FABRIC GRADE C



FABRIC GRADE E



FABRIC DIRECTION  
\*See page 50 for Fabric Direction  
Application Guidelines.



VINYL CATEGORY A



BLACK  
TP00



BEIGE  
TP02



GRAY  
TP06



COFFEE  
TP28



IVORY  
TP81

VINYL CATEGORY B



DENALI

SAND  
TP05



WALLABY

OFF WHITE  
TP11



AVANTI

CHOCOLATE  
TP23



RED  
TP37



DENALI

E. SADDLE  
TP55



DENALI

SADDLE BROWN  
TP59



AQUA  
TP70



ROYAL BLUE  
TP76



WALLABY

RED  
TP88

FABRIC DIRECTION  
\*See page 50 for Fabric Direction  
Application Guidelines.



# GUIDELINES

Fabrics that are **patterned, textured, or have sheen** can have a **distinctly different appearance if applied in different directions on chairs or panels**. Because of these differences, as well as width limits to how some fabrics can be applied to Gebesa products\*, it is important to understand fabric applications.

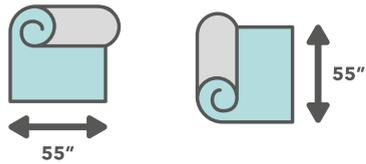

Fabrics **cannot be applied warp horizontal/railroaded** on panels with a **height greater than 48 inches** because panel height is greater than fabric width.

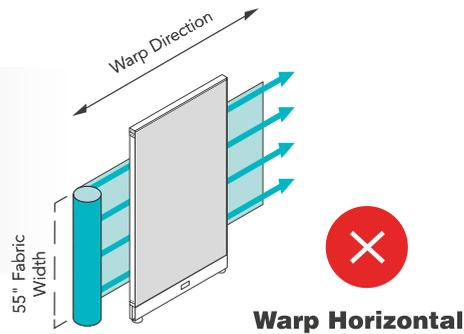

Fabrics **cannot be applied warp vertical** on panels with a **width greater than 48 inches** because panel width is greater than fabric width.

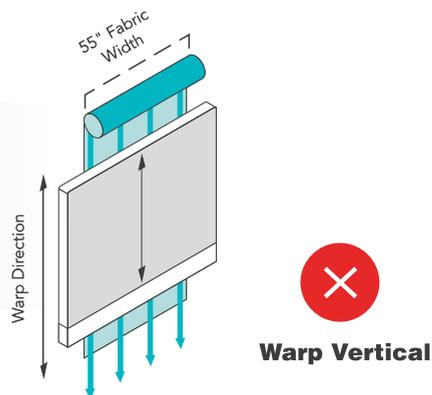

*Gebesa is not responsible for charges associated with replacement or reupholstering of products due to incorrect fabric specifications.*

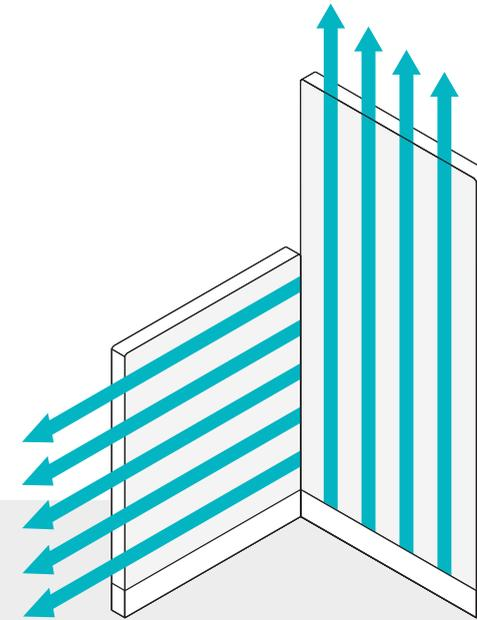

The combination of tall panels (height of 55 inches or more with warp vertical/off the roll) with short panels (height of 45 inches or less with warp horizontal) results in fabric patterns running in opposite directions.

### The following options are available:

- Use solid or non-directional fabrics. (Various Gebesa fabrics are noted as "non-directional.")
- Specify warp vertical/off the roll application for fabrics that are standard warp horizontal.

If you require warp vertical and it is not standard for your fabric choice, you must specify the warp vertical option on each line of the order.

**Gebesa**  
CREATING AMAZING SPACES